

DOMEKT



VERSO



RHP



KLASIK



VENTILATION EQUIPMENT

CATALOGUE | 2023

komfovent

**VENTILATION
EQUIPMENT**



Introduction

4

DOMEKT

22

VERSO

54

Residential ventilation units

Commercial ventilation units

Why KOMFOVENT?	4
Wide range	6
Energy-saving technologies	8
Control systems	12
Smart control systems C6, C6M, C8 for DOMEKT units	15
Control system C5 for VERSO, RHP and KLASIK units	18
Selection software	20
Komfovent + BIM	21

DOMEKT	24
Domekt R	26
Domekt R 150 F C8	27
Domekt R 200 V C8 NEW	28
Domekt R 200 V C8 E1 NEW	29
Domekt R 250 F C6	30
Domekt R 300 V C8	31
Domekt R 300 F C8	32
Domekt R 400 V C6M	33
Domekt R 400 H C6M	34
Domekt R 400 F C6M	35
Domekt R 450 V C6M	36
Domekt R 600 V C6M	37
Domekt R 600 H C6M	38
Domekt R 700 V C6M	39
Domekt R 700 H C6M	40
Domekt R 700 F C6M	41
Domekt R 900 V C6M	42
Domekt CF	43
Domekt CF 200 F C8	44
Domekt CF 200 V C6M	45
Domekt CF 250 F C6	46
Domekt CF 300 V C6M	47
Domekt CF 400 V C6M	48
Domekt CF 500 F C6M	49
Domekt CF 700 V C6M	50
Domekt CF 700 H C6M	51
Domekt CF 700 F C6M NEW	52
Domekt S	53

VERSO STANDARD	59
Verso R Standard	60
Verso R 1000 U C5	61
Verso R 1000 FSA C5 NEW	63
Verso R 1300 U C5	64
Verso R 1300 F C5	65
Verso R 1500 U C5	66
Verso R 1500 F C5 NEW	67
Verso R 1700 U C5	68
Verso R 2000 U C5	69
Verso R 2000 F C5	70
Verso R 2500 H C5	71
Verso R 3000 U C5	72
Verso R 3000 F C5	73
Verso R 4000 U C5	74
Verso R 5000 V C5	75
Verso R 5000 H C5	76
Verso R 7000 V C5	77
Verso R 7000 H C5	78
Verso CF Standard	79
Verso CF 1000 U C5	80
Verso CF 1000 F C5	81
Verso CF 1300 U C5	82
Verso CF 1300 F C5	83
Verso CF 1500 F C5	84
Verso CF 1700 U C5	85
Verso CF 2000 F C5 NEW	86
Verso CF 2300 U C5	87
Verso CF 2500 F C5	88
Verso CF 3500 U C5	89
Verso CF 5000 V C5	90
Verso S Standard	91
Verso Pro, Verso Pro2	92
VERSO Pro, VERSO Pro2 design	93
Sizes and capacities	98



RHP 102

Ventilation units with a rotary heat exchanger and an integrated heat pump

RHP Standard	105
RHP 400 V C5	106
RHP 600 U C5	108
RHP 800 U C5	110
RHP 1200 U C5	112
RHP 1600 U C5	114
RHP Pro, Pro2	116

KLASIK 120

Industrial / commercial ventilation units

KLASIK	122
Klasik R	123
Klasik CF	123
Klasik S	123
Klasik RA	123
KLASIK units for hygienic application	124
KLASIK design	125

Accessories 129

Filters classification and standards	129
Silencers	130
Motorized closing dampers	130
Pipework package	130
Water and direct evaporation air coolers	131
Ducted heaters and coolers	132
DX heat pumps / outdoor units	133
Accessories for unit outdoor installation	134
Air quality control (AQC)	135
Override function (OVR) – remote air flow corrections	135
Wireless router	135
Variable air volume control (C5 / C6 / C6M)	135
Unit marking and ordering samples	136



LITHUANIA

 | 

40 000 m² | > 600

 made with GREEN ENERGY

Why KOMFOVENT?

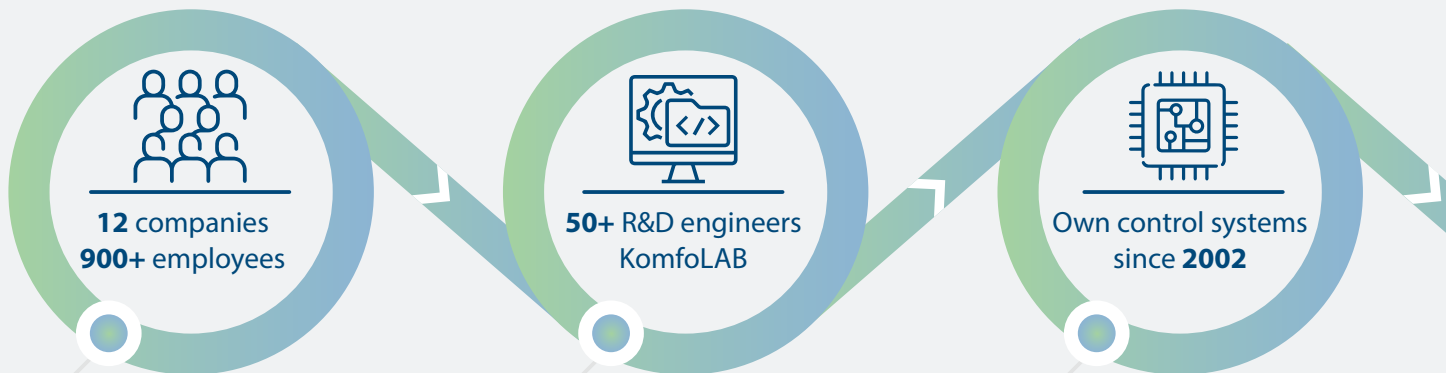

TEAM

KOMFOVENT brand unites a group of 12 companies, operating in Lithuania and other European countries employing over 900 people who: research and develop, manufacture and distribute air ventilation system products.

PRODUCT DEVELOPMENT

Air handling units and the major part of their components are developed by a team of over 50 highly qualified engineers. All designed prototypes are tested by KomfoLAB – an in-house laboratory using the latest testing equipment – to comply with actual or upcoming standards and norms. International requirements, as well as customer needs, are well known by KOMFOVENT R&D team.

IN-HOUSE MADE CONTROL SYSTEMS



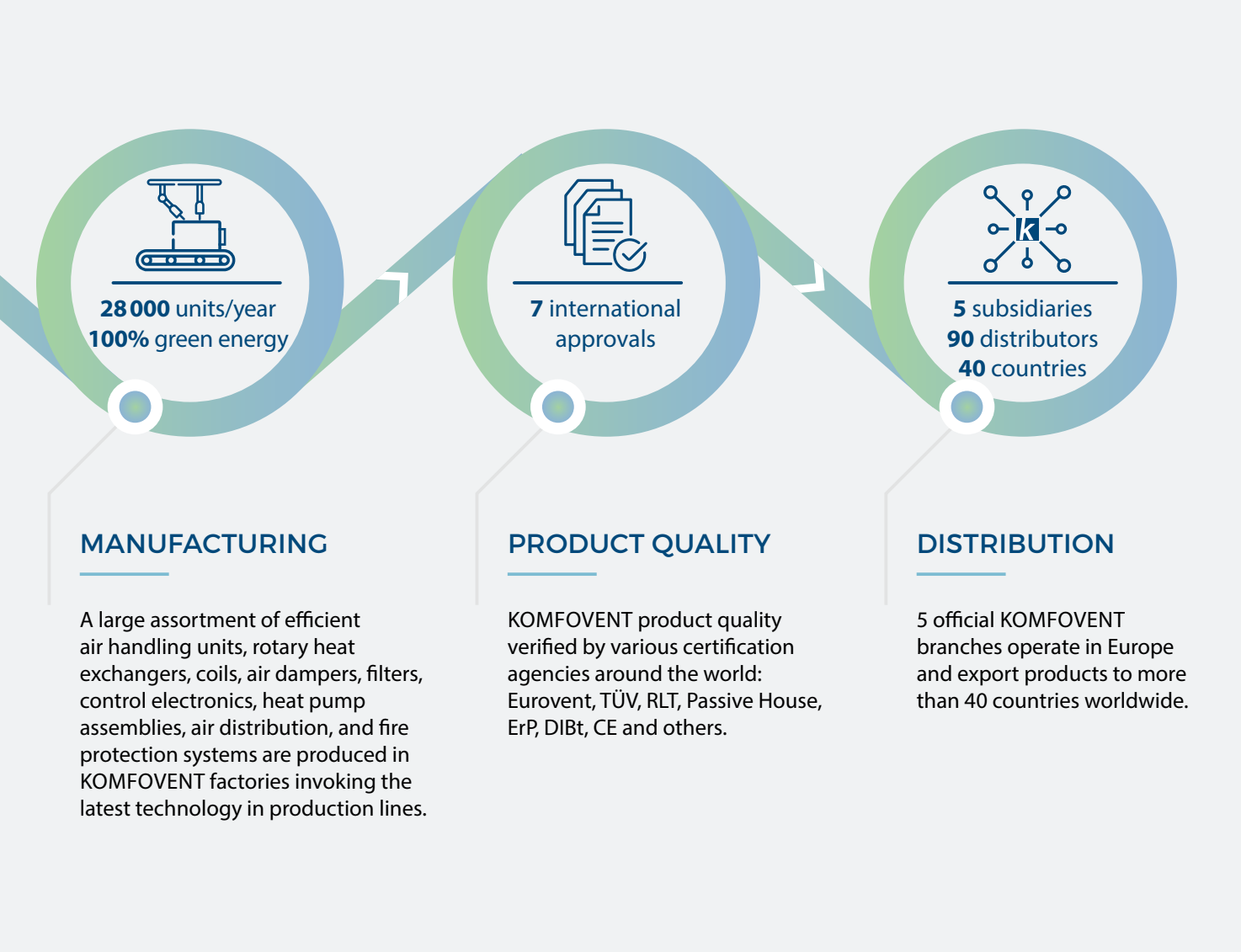

KOMFOVENT develops electronics and software, which provide unique ventilation control capabilities for professional and domestic users. Fine-tuned algorithms ensure a wide range of functions and connectivity options.



Wide range

DOMEKT



Residential ventilation units with heat recovery. Depending on the individual requirement, a rotary or counterflow plate heat exchanger, vertical, horizontal or flat units can be selected from a wide range of modifications.

Capacity	50–1000 m ³ /h
Control system	  
Selection software	 DOMEKT

VERSO

VERSO Standard

Standardized choice of air handling units for commercial applications. Rotary or counterflow plate heat exchanger, vertical, horizontal, universal or flat units with the integrated control system.

Capacity	250–40 000 m ³ /h
Control system	
Selection software	 VERSO

VERSO Pro

Modular units for commercial and industrial premises. This series offers a large number of configurations to meet the most demanding requirements. Rotary or counterflow plate heat exchanger units with integrated control system.



VERSO Pro2

A new generation of energy saving modular units with the integrated control system. This series offers 1,6 million possible combinations for commercial and industrial projects with high requirements.

RHP

RHP Standard

All-in-one units with integrated heat pump provide fresh air, heating, conditioning and humidity recovery for residential and small commercial premises.

Capacity	250–33 500 m ³ /h
Control system	
Selection software	 VERSO

RHP Pro



Modular all-in-one units with integrated heat pump provide fresh air, heating, conditioning and humidity recovery for commercial and industrial premises.

RHP Pro2





A new generation of energy saving modular all-in-one units with integrated heat pump for complete indoor climate control.

KLASIK

A series of the unique ventilation units for the most complex projects. The largest selection of heat exchangers, fans, heaters, coolers and humidifiers. Non-standard dimensions, hygienic version, anti-corrosion coatings and many other options.

Capacity	250–100 000 m ³ /h
Control system	
Selection software	 KLASIK

Equipment by application

Residential areas	Commercial premises		Industrial buildings
			
DOMEKT 50–1000 m ³ /h	VERSO Standard 250–7000 m ³ /h	VERSO Pro, Pro2 1000–40 000 m ³ /h	KLASIK 250–100 000 m ³ /h
	RHP Standard 250–1700 m ³ /h	RHP Pro, Pro2 1000–33 500 m ³ /h	

Modifications to standard products

Rotary heat exchanger

L/A – aluminium, condensing rotor – a standard for Domekt R and Verso R Standard units. The optimal efficiency and pressure loss ensures the shortest time to pay off the investment.

SL/A – aluminium, condensing rotor with increased surface and efficiency.

L/AZ – sorption-enthalpy rotary heat exchanger coated with special hygroscopic zeolite coating. The most effective control of humidity and the most comfortable indoor climate.

Counterflow plate heat exchanger

Condensing – plate heat exchanger made of special polystyrene or aluminium; there are no moving parts, which results in long-term operation.

Diffusion-enthalpy – plate heat exchanger made of special membrane ensures the best heat and humidity recovery, also known to be hygienic and durable.

Duct connection

H – horizontal

V – vertical

U – universal, 16 installation options

F – flat (please refer to the installation options in the specific unit page)

Inspection side

Left or right inspection side is available for all units (see 136 p.).

Cooler

HCW – designed for air cooling using cold water (water-glycol mixture), provides a higher comfort level in rooms.
HCDX – direct expansion changeover heater and cooler in one piece. Used with outdoor heat pump unit.

Heater

E – electric heater.

DH, SVK – a water duct heater is installed in the duct and must be ordered separately. Heaters are mounted outside of the unit in any user-convenient place. 0 ... 10 V heater control included in automatic control system.

HCW – heater-cooler one for both – heating and cooling. Ideal for buildings using geothermal energy.

Abbreviations

ODA – outdoor air

SUP – supply air

ETA – extract air

EHA – exhaust air

ETB – by-pass extraction without heat recovery.

ETH – kitchen hood connection (without heat recovery).

L_{war} dBA – A-weighted sound power level at reference flow rate.

L_{par} dBA – A-weighted sound pressure level in 10 m² normally isolated room, distance from casing – 3 m.

Energy-saving technologies



Recently, when energy performance requirements for buildings are constantly tightening, higher demands for ventilation systems are placed, knowing they are directly related to many energy parameters of the building: heating, cooling, humidity regulation and electrical consumption. Keeping that in mind, when choosing technologies and solutions for the ventilation systems, it is more important to consider operating costs and payback time than the initial investment – no one will argue, that the most advanced technologies pay for themselves in the shortest possible time.

Efficient heat exchangers

Rotary – condensing and sorption-enthalpy

Rotary heat exchangers are ideal for cold climate zones – they work efficiently both in winter and summer, do not ice even at extremely low temperatures, which saves you the most energy and is likely to pay off quickly. The sorption-enthalpy rotor provides better performance than a condensing rotor – better humidity control, higher comfort and greater energy savings for air conditioning.

Plate – condensing and diffusion-enthalpy

The plate heat exchangers are more appropriate for the warmer climates, because, when the outside air temperature is negative, the icing begins and that results in a loss of energy. Diffusion-enthalpy heat exchangers are more efficient than condensing ones. Diffusion-enthalpy, like rotary heat exchangers, humidifies the air in the winter and dries it in the summertime – efficiently saving energy.

RHP double heat recovery – rotary heat exchanger and heat pump

The most efficient are RHP air handling units having double heat recovery and additional features: integrated heat pump efficiently heats the air in winter, while in the summertime it cools the air like an air conditioner.

Innovative control system

Preprogrammed operating modes and schedules allow the user to significantly reduce the energy consumption of the ventilation.

By controlling the ventilation intensity according to the CO₂ sensor signal, an optimal comfort level with minimal energy consumption is always maintained.

VAV – variable air volume function with additional sensors makes it possible to fully realize the function of "ventilation according to the need" – the ventilation intensity in each room is regulated according to a specific need, maximally saving energy.

Permanent magnet (PM) technology fans

The highest energy efficiency Ultra and Super Premium class fan motors provide minimum power consumption. Due to the optimized design of internal winding and the use of powerful permanent magnets, energy losses of the motor are minimized, resulting in low heat emittance and stable efficiency under different load or rotation speeds. Fans and their special design impellers are statically and dynamically balanced, thus the quiet and harmonious operation of the AHU is guaranteed.

Rotary heat exchangers

Operating principle

The rotary heat exchanger transfer effect is based on the accumulation principle – the rotating aluminium wheel with small channels is warmed up by extract indoor air and then the heat is transferred to the outdoor intake. At low temperatures, humidity from extract air condensates on the rotor surface and humidifies the outdoor intake air, where absolute humidity in winter is always too low to provide comfortable conditions. Therefore, such rotary heat exchangers are called condensing.

Advantages

- Efficiently recovers the heat even the outside temperature drops to -30 °C.
- Efficiently recovers cold during the summer and reduces conditioning costs.
- Recovers the humidity in the room while maintaining the optimal comfort level.
- Advanced design ensures minimal mixing of air flows.
- No drainage is necessary – easy unit installation.
- No primary heater is necessary as the heat exchanger does not ice.

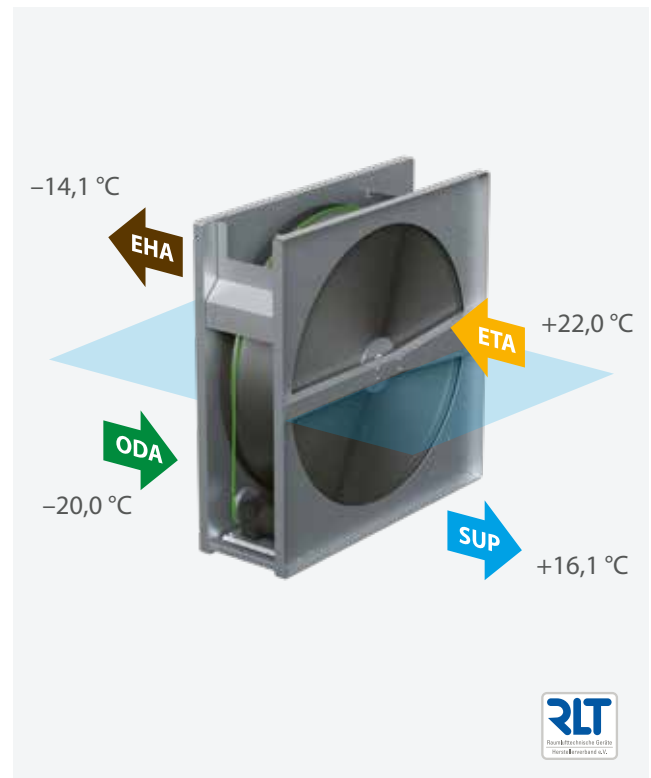

Counterflow plate heat exchangers

Operating principle

The plate heat exchangers are made of aluminium or plastic plates, which have gaps for air to flow. Fresh outdoor air and extract outdoor air flows in opposite directions through every second gap of the entire surface of the plates. Extract air transmits thermal energy to fresh outdoor air. Air flows do not mix. During winter, when the air is extracted from the room, the air cools in the heat exchanger and the humidity in it turns into ice. For this reason plate heat exchangers are more suitable for a medium and warm climate zone where there is no significant frost and no danger of icing. In cold weather, the automatic control system solves the problem of icing, but a lot of heat is lost, resulting in decreased seasonal efficiency and increased payback time.

Advantages

- High thermal efficiency.
- Very low air mixing between flows.
- Perfect solution for premises with high humidity, as it effectively eliminates humidity in the cold seasons.

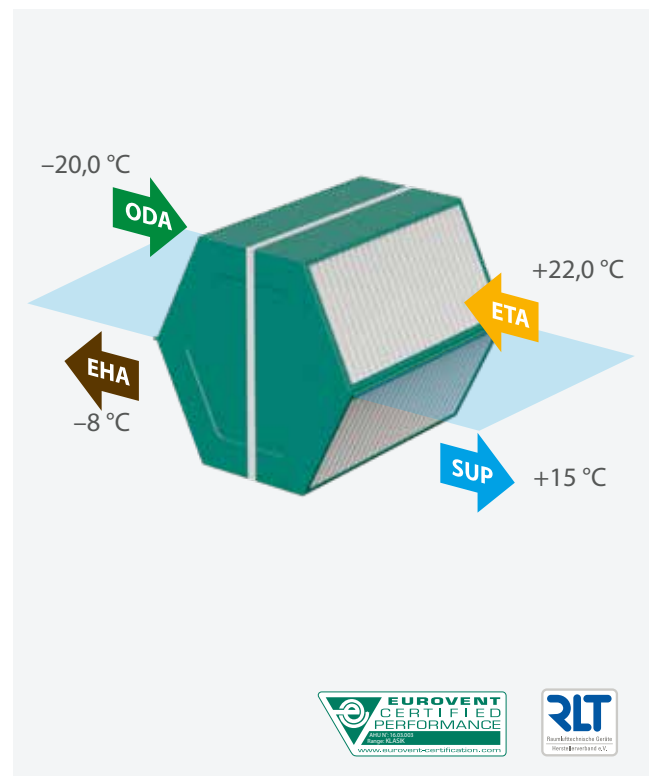

Humidity transferring heat exchangers

Humidity transferring heat exchangers are one of the most efficient ways to control indoor humidity. Since water vapor in the air carries lots of hidden (latent) energy, controlling humidity not only helps to maintain comfortable indoor conditions but also reduces the needed power of humidifiers and air conditioning costs.

Sorption-enthalpy rotary heat exchanger

Operating principle

The internal surface of the sorption-enthalpy rotor has a special zeolite coating, which catches water molecules from the air and transfers it into another flow when the wheel rotates. In such a way humidity exchange up to 90 % is achieved and rotor effectively humidifies the supply air in the winter and dries it in the summer.

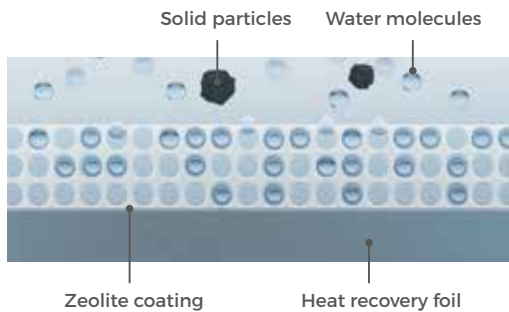

Advantages

- Reduced demand for air conditioning power.
- Reduced demand for air humidification and dehumidification power.
- More efficient use of passive cooling.
- Can operate without freezing up to -30 °C.

Diffusion-enthalpy counterflow heat exchanger

Operating principle

Outlet air humidity is recovered to the inlet air through a special patented membrane. Only water molecules can get through the membrane and solid particles or bacteria can not get back into the premises.

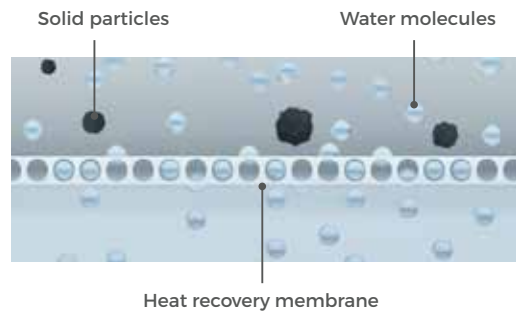

Advantages

- Reduced demand for air humidification and dehumidification power.
- Reduced demand for air cooling power in summer.
- More durable and hygienic if compared to enthalpy plate heat exchanger made of cellulose.
- Can operate without freezing up to -10 °C.

Heat exchanger type impact on indoor climate comfort and operational costs

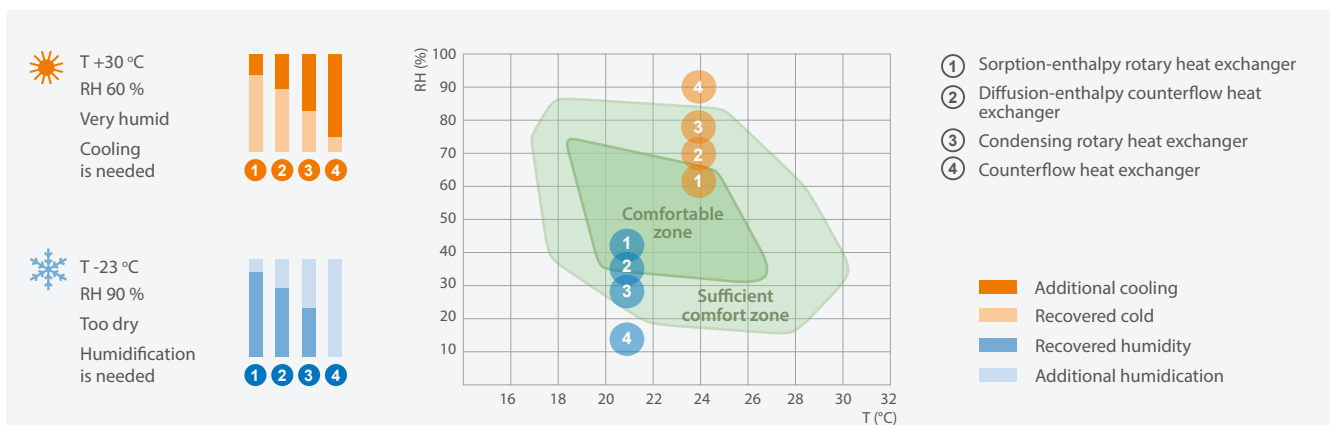

RHP double heat recovery – triple the benefits

RHP ventilation unit is a complex solution that integrates all indoor climate support systems into one unit: ventilation, air heating and conditioning, humidity recovery and dehumidification, air quality, and air filtering. The heat pump is completely integrated into the casing of the air handling unit making it simple to install and easy to operate.



Advanced Technologies

The latest and most advanced engineering and technological solutions developed and refined in the fields of heating, ventilation, and air conditioning are included in RHP air handling units.

Operating principle

The heat pump and rotary heat exchanger work together as a perfect recuperation tandem. The main energy saving component – the rotary heat exchanger works efficiently for almost the whole year, except for the times when the outside and indoor temperatures are almost equal. When higher heating or cooling demand is needed, a second recovery step (heat pump) starts supplying warm or cold air to maintain the desired temperature. The "heart" of the heat pump, high-efficiency inverter compressor complements and extends the capabilities of the air handling unit – it effectively provides heat even when the outside air temperature is as low as -15 °C or operates as the

central air conditioner during hot summer. Intelligent automation algorithms control all processes, maintaining optimal indoor climate with minimal energy use. Besides that, all ventilation and heating/cooling parameters are at the touch of a button on the control panel display.

Advantages of the RHP solution

- Double recovery – rotary heat exchanger + heat pump, return 100 % heat to the premises during winter.
- The heat pump works in the summer as an air conditioner.
- An integrated control system manages all indoor climate processes from the single user interface.
- Faster and easier installation and maintenance compared to individual heating, ventilation, and air conditioning systems.
- No external unit is needed to be mounted outside of the building.

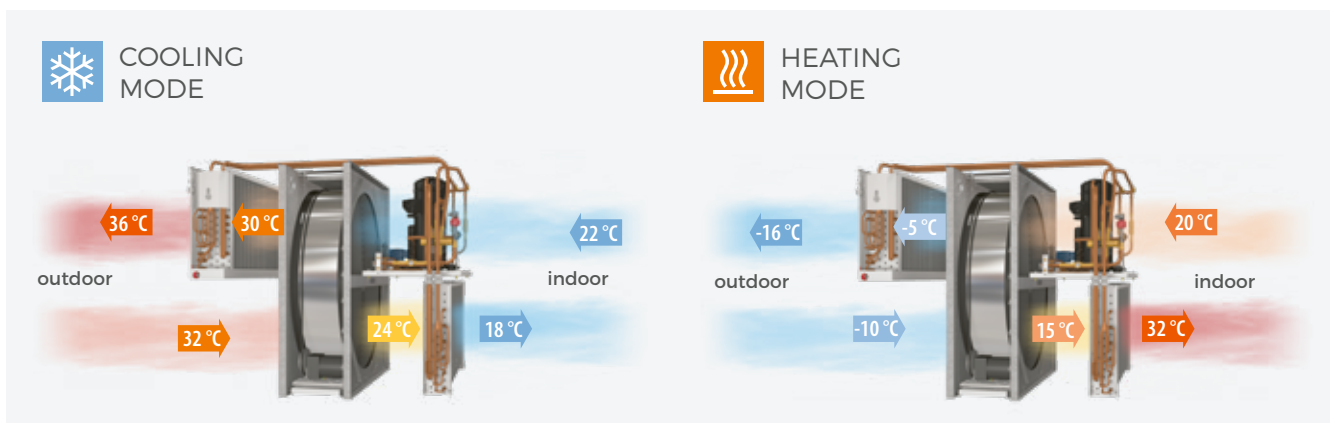

Control systems

For end users



Smart control systems C6, C6M, C8

The core philosophy behind the design of these control systems were that the ventilation unit would operate properly without constant adjustments from the user.

Control panels

C6.1

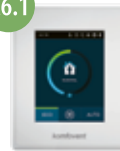

- Setting of all parameters from the panel
- Indication of parameters
- Colored touch-sensitive LED display

C6.2



- Simple control
- Operation modes
- Touch-sensitive screen

For professionals

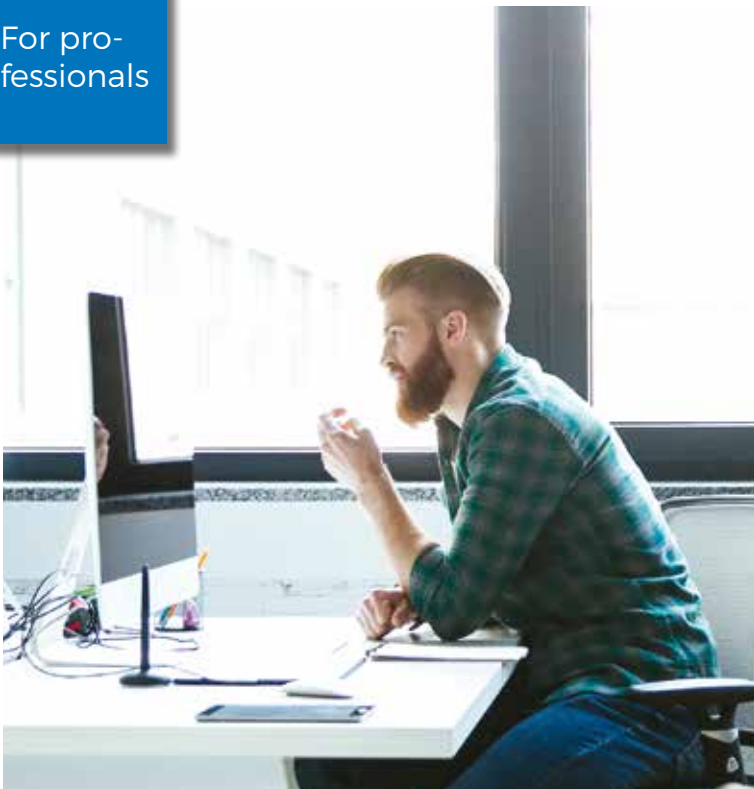

Control system C5

The user is given detailed information about the operation of the air handling unit. A variety of modes and functions allows you to choose the most optimal operating mode that maximizes energy saving.

Control panel

C5.1



- Integrated thermometer and hygrometer
- Colour touch-sensitive LED display
- Smart control of parameters

VENTILATION BY DEMAND

The possibility to connect various sensors and combine them with a wide range of built-in functions allow having ventilation only when and where it is needed, therefore energy is saved.

WEB SERVER

All units are with an integrated web server, thus the operation of the ventilation system can be monitored and managed from any device using an internet browser.

READY TO USE

All units are completely prewired and have integrated electronics, which are already pre-programmed with default ventilation modes and temperature set points.

APPS

User-oriented mobile apps, fully replicate the control panel functions.

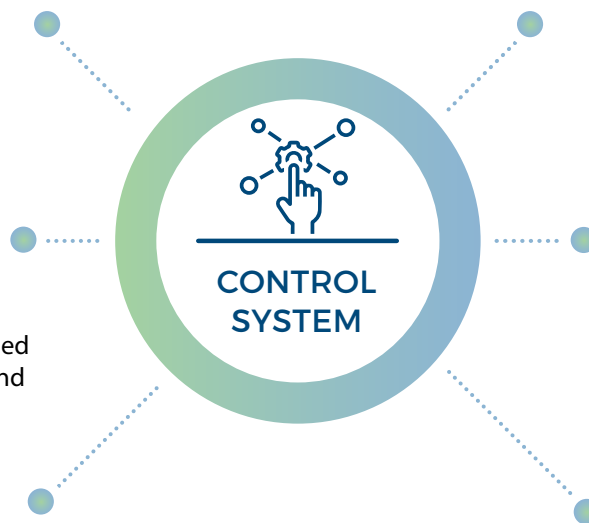

BMS

Implemented BACnet and Modbus protocols enable simple connection into Building Management System as a result whole buildings engineering systems can be controlled at a single access point.

USER-FRIENDLY INTERFACE

Convenient and intuitive navigation on the touch screen control panel, computer or smartphone, ensures easy ways to monitor ventilation parameters and change its settings.



LOG PLOTTER SOFTWARE

Analysis tool for professionals. Free to use "Log plotter" software for service and maintenance staff. It helps to analyse the operation history of the air handling unit from various perspectives.

Available on – www.komfovent.com



Your home indoor climate in your hand with **Komfovent Control app**



Smart control systems C6, C6M, C8 for DOMEKT units

For both: beginners and advanced users

A user-friendly interface enables intuitive navigation and control of the unit. The core philosophy behind the design of C6, C6M, C8 – the ventilation unit would operate properly without constant adjustments from the user. Different ventilation modes are optimized for the user's daily needs. Automatic air quality control selects the most appropriate mode and ensures the comfort conditions in the room.

Advanced users can control a unit's operation according to his needs, as many settings and control possibilities are provided as well:

- Air flow control: CAV / VAV / DCV*.
- Intensity control by air quality, CO₂, humidity level.

Operating modes

- 8 preset modes.
- Intelligent energy saving algorithms.
- Automatic air quality control with optional AQ sensor.
- Extensive weekly schedule.

Energy counters*

- Real-time energy consumption indicator.
- Possibility of observing the running costs of the ventilation unit.
- Heat recovery counter.



* Except C8 control system.

Control options



App "Komfovent Control"



Control panel



Web Server



Connectivity & Protocols



"Komfovent Control" app

A new cloud-based application is designed to control residential ventilation units with C6, C6M, C8 control system. A user-friendly interface ensures intuitive control. As the application fully replicates a control panel functions, you will have access to all monitoring and control possibilities available in the control panel. The application is available on Google Play, App Store and Huawei AppGallery.



SMART CONTROL FUNCTIONS	C6	C6M	C8
Air temperature control The unit can control air temperature according to user-defined supply or extract temperature settings. If the user desire, room ambient temperature can also be maintained according to the temperature sensor located in the control panel	✓	✓	✓
Temperature balance control The temperature support value of the supply air is automatically set on the basis of the current extract air temperature, i.e., the extract air temperature and the supply air temperature will be the same	✓	✓	✓
Fan intensity control Fan speed can be adjusted smoothly between 20-100 %, thus ventilation intensity can be set easily by the user	✓	✓	✓
Constant air volume control (CAV) The unit supplies and extracts a constant air volume as set by the user, regardless of changes in the ventilation system	✓	✓	
Variable air volume control (VAV) The unit supplies and extracts air volume correspondingly to the ventilation requirements in different premises	✓	✓	
Directly controlled volume (DCV) The air volumes are controlled by direct external control signals	✓	✓	
External water coil control There is an estimated an additional water duct heater or cooler control that can be activated by the user on the control panel	✓	✓	
External DX unit control There is estimated an additional external direct expansion (DX) unit control that can be activated by the user on the control panel	✓	✓	
External heater or cooler control There is estimated one additional duct heater or cooler control that can be activated by the user on the control panel. Water or direct expansion (DX) heating/cooling device can be connected and controlled as a second step for reaching desired air temperature			✓
Combi-coil control Heating or cooling with water by using just one circulation pump and one 3-way valve. Heating and cooling modes can be switched automatically according to water temperature, or by an external switch		✓	
Weekly operation schedule It is possible to choose one of the four pre-set weekly operation schedules. If necessary, the schedule can be modified. As well holiday schedule can be set, when the unit will not operate for most of the time, but ventilate premises occasionally	✓	✓	✓
Air quality control (2 sensors) Upon connecting the additionally ordered external air quality or humidity sensors, the ventilation intensity is chosen automatically. Two air quality sensors can be used at the same time, thus comfort can be controlled according to two different parameters or in two separate rooms if needed	✓	✓	
Air quality control (1 sensor) Upon connecting one air quality or humidity sensor, the ventilation intensity is chosen automatically according to its readings. In this way, optimum room comfort is ensured with the minimum energy cost			✓
Cool recovery During the summer season, in the conditioned premises cool from extract air is returned back into the premises	✓	✓	✓
Temperature saving function The automatic function attempts to maintain comfortable temperature conditions in the premises by reducing the ventilation intensity, i.e., it prevents excessive cooling down or overheating of the premises	✓	✓	✓
Free cooling When the room temperature air exceeds the set value, and the outdoor temperature is lower than the room temperature, the heat recovery and the other heating/cooling processes are blocked automatically and free cooling is performed only by fans	✓	✓	✓
Variable speed rotary heat exchanger By modulating the rotation speed of heat exchanger, it is possible to maintain supply air temperature more precisely, to reduce rotation noise and to prolong exchanger motor lifetime		✓	
Ventilation control by 3 external contacts Air flow can be controlled by three external contacts, each of which can be assigned to different ventilation intensity	✓	✓	
Ventilation control by 1 external contact Airflow can be controlled by an external contact, which can be assigned to change ventilation intensity when needed, for example together with kitchen hood operation			✓

SMART CONTROL FUNCTIONS	C6	C6M	C8
Control via internet browser or smartphone app When the device is connected to the computer network or the Internet, the user-friendly web interface allows the operator to control the equipment with a computer or with another mobile device	✓	✓	✓
Air dehumidification If the relative humidity of the room exceeds the set limit, the air handling unit's operating intensity is increased until the humidity is reduced to the desired level. To make the function more efficient, the unit is recommended to be equipped with a refrigeration unit and an additional duct humidity sensor	✓	✓	✓
Energy counters Real-time energy consumption indicator. Possibility of observing the running costs of ventilation unit. Heat recovery counter. Day, month or overall time counters are available for ventilation unit operation analysis	✓	✓	
Operation time counters Fan, heat exchanger and heater working times are monitored. Day, month or overall time counters are available for ventilation unit operation analysis			✓
Timed ventilation modes Three ventilation modes can be started for a duration of several minutes, without changing programmed schedules. User can simply set a timer from 1 to 300 minutes, for the desired mode to run ignoring the main weekly schedule	✓	✓	✓
Operation on demand The ventilation unit will operate when the air quality in the premises exceeds the set levels. An additional air quality sensor is required or a humidity sensor integrated in the control panel can be used for the same purpose	✓	✓	✓
SAFETY FUNCTIONS	C6	C6M	C8
Filter clogging indication Clogging of the air filters is measured depending on the duration and intensity of the unit's operation. The user is informed by a message, when it is time to change air filters	✓	✓	✓
Heat exchanger frost prevention Units with a counterflow plate heat exchanger have a primary electric heater that is controlled as needed, and is operated only at the capacity to ensure frost protection. In this way, the ventilation unit can operate in low outside temperatures	✓	✓	
Heat exchanger frost prevention A special frost protection algorithm combining by-pass damper and fan speed regulation prevents freezing of counterflow heat exchanger even at negative outdoor temperatures (up to -10 °C). For additional protection, duct mounted pre-heater control is also available			✓
Heat exchanger failure indication In units with plate or rotary heat exchanger, a control system monitors the thermal efficiency, and if it does not reach the stated level, a fault is indicated	✓	✓	✓
Water heater frost protection For the duct mounted water heater, it is ensured maximum protection from water freezing during the unit's operation. Even when the unit is switched off, warm water circulation is supported as additional help during the cold season	✓	✓	✓
Electric heater overheat protection Electrical heater shuts down automatically in case of overheating to prevent damage to the heater components and electronics. Additionally, when the unit is stopped during the heater operation, fans will continue to operate for a set time period to cool down the heater	✓	✓	✓
Low air flow indication If the ventilation unit does not reach the set air volume during the specified time, the unit's operation is stopped	✓	✓	
Emergency shut down in case of fire The external fire alarm is provided when the unit is connected to the building fire alarm system. There is also an internal fire alarm to detect an increased temperature inside the air handling unit or the ventilation system	✓	✓	✓
Fire damper control Possibility to monitor and perform periodical fire damper system tests directly from the control panel. External fire damper controller constantly checks fire dampers functionality and gives feedback to the ventilation system	✓	✓	✓
Emergency shut down when temperature reaches critical limits When the supply air temperature drops below or exceeds the permitted value, the unit is stopped	✓	✓	✓
Intelligent self-diagnostic Self-check function of controller and elements of the air handling unit. If a fault is detected, controller terminates the operation of the unit and warns about such a fault using the respective informative messages	✓	✓	✓

Control system C5 for VERSO, RHP and KLASIK units



Detailed information for the user

- Air flow indication (m³/h, m³/s, l/s).
- Thermal efficiency of the heat exchanger (%).
- Heat exchanger energy recovery (kW).
- Thermal energy savings indicator (%).
- Air heater energy consumption (kWh).
- Heat exchanger recovered energy counter (kWh).
- Fan's energy consumption (kWh).
- SFP factor of PM fans.
- Clogging level of filters (%).

Various operating modes

- 5 different operation modes: *Comfort1*, *Comfort2*, *Economy1*, *Economy2*, and *Special*. User may set supply and extract air volumes as well as air temperature for each of mode separately.
- Temperature control modes: Supply air / Extract air / Room / Balance. Possibility to select which temperature to maintain.
- Flow control modes: Constant Air Volume (CAV), Variable Air Volume (VAV), Directly Controlled Volume (DCV).
- Universal operating schedule with up to 20 events, for each of them the user can assign weekday(s) and one of five operating modes.
- Holiday scheduling allows the user to change operating mode or switch off the air handling unit on some dates of the year. Up to 10 events are possible.

Extended control possibilities

- Controlling up to 30 units connected into a network from one panel.
- Ability to connect the controller to the Internet network and manage it via a standard internet browser without any accessories.
- Possibility to control air handling unit by Smartphone via Android OS or iOS application software.
- Ability to control the unit not only by a control panel or a computer, but also by different external devices (switch, timer, etc.) and systems (e.g. the smart house system).

Control options



App "Komfovent C5"

C5.1



Control panel



Web Server

BACnet



Connectivity & Protocols





"Komfovent C5" app

Application is designed to control air handling units with the integrated C5 control system. User-friendly interface is intuitive for both experienced and less experienced users. As the application fully replicates a control panel functions, you will have access to all monitoring and control possibilities available in the control panel. The application is available on Google Play and App Store.

CONTROL FUNCTIONS

Air quality control

Two different air quality values may be set for two different unit operating modes (e.g., Comfort and Economy). These values will be maintained by automatically increasing or reducing the intensity of ventilation

Outdoor compensated ventilation

This function adjusts the air volume depending on the outdoor temperature. It is possible to enter four temperature points where two of them define winter conditions and the other two define summer conditions. Upon entering the compensation curve according to the outdoor temperature, the current intensity of ventilation is decreased or increased accordingly

Summer night cooling

This function is intended for energy saving in summer: utilizing the outside chill of night hours to cool down the heated rooms. The user may enable or disable function at any time as well as set the room temperature at which the function is automatically activated

Override function

Override control of the unit can be performed by an external device (timer, switch, thermostat, etc.). The signal received from the outside activates the function which switches the unit to the pre-programmed mode ignoring the current operating mode

Minimum temperature control

This function forces the reduction of the supply and extract air volumes set by the user when the heater capacity available in the unit is insufficient and/or heat recovery does not ensure the supply of the minimum temperature to the room

Operation on demand

The air handling unit start-up function is designed to start the unit when it is off and one of the selected parameters (CO₂, air quality, humidity, or temperature) has exceeded the critical limit

Humidity control

An air handling unit can control external humidifiers or dehumidifiers. User is able to choose the humidity control location: supply air, extract air or room. The user is also able to choose the method of control: humidification, dehumidification or both at a time

Circulation pumps control

By default hot and cold water pumps are controlled according to the current need for heating or cooling. If needed, water pump control according to outdoor temperature is also possible

Air flow density compensation

Air density depends on the temperature. The controller has a function which adjusts the air flows automatically to avoid any misbalance in rooms while being ventilated

Change-over function

Control of combined water heater cooler and DX cooler reversing to the heating mode

Additional zone control

Option for independently control of additional heaters and coolers in separately ventilated area. You can control up to two additional zones or a preheater (electric or water). Also applicable to STANDARD series

Recirculation control

The controller has a modulated extract air recirculation function. There are four control options: 1) recirculation according to the air quality which may be defined by one of the selected parameters: CO₂, air pollution by organic components and chemical substances, humidity or temperature; 2) recirculation according to the outdoor temperature curve; 3) recirculation according to a weekly schedule; 4) recirculation controlled by an external device

Recirculation limitation by temperature

Recirculation may be limited according to the need for heating or cooling. In cases where recirculation is controlled automatically according to one of the air quality sensors or the recirculation level set by the user, the required value of extract air recirculation may be ignored if recirculation heats or cools down the supplied air too much. In such a case recirculation is forcibly reduced until the temperature of supply air set by the user has been reached

SAFETY FUNCTIONS

Rotary or plate heat exchanger failure protection

This function observes the thermal efficiency of the heat exchanger. If it does not reach the required level a fault is recorded and indicated

Rotary or plate heat exchanger anti-frost

Under the low outdoor temperature conditions, this function is constantly observing decreasing tendency of the heat exchanger thermal efficiency, determines the moment when the heat exchanger starts freezing, and activates the defrosting function automatically

Multi-level frost prevention

Units with counterflow heat exchangers can be selected with a multi-level frost prevention option. In such a case, the heat exchanger is fitted with a four-segment damper, segments of which close and open in turns, thus preventing the heat exchanger from freezing under low outdoor temperatures

Service time

A warning message appears when the continuous operation of the AHU has reached 12 months

Rotor warm-up function

This function forcibly activates the rotary heat exchanger if the air handling unit is turned off for some time and the temperature inside the unit or ventilation system is low enough for the rotor to freeze

Circulation pumps start-up in off mode

This function starts water circulation pumps for a short period of time when they are off longer than the set period

Water coil frost protection

Return water temperature is maintained under low outdoor temperatures, avoiding the possibility of frost at any time, even if the unit is on standby. At the same time alarm signal from the water pump, or water flow sensor input is available for extra protection

Warning for too low air flow

If the air handling unit does not reach the air volume set within the time set, the user is warned by an informative message

External stop

Shut-down function from external device. May be used with or without an automatic unit restart

Emergency shut-down in case of fire

The external fire alarm is provided when the unit is connected to the building fire alarm system. There is also an internal fire alarm to detect an increased temperature inside the air handling unit or the ventilation system

Intelligent self-diagnostic

Self-check function of controller and elements of the air handling unit. If a fault is detected, controller terminates the operation of the unit and warns about such a fault using the respective informative messages

KOMFOVENT selection software



DOMEKT selection software

- For DOMEKT units with a capacity from 50 to 1000 m³/h.
- Parameters are calculated for specific climate and operating conditions.
- Selection of unit's accessories.
- Comparison of the units.
- DOMEKT 3D REVIT models are available in the selection software.

KLASIK selection software

- For units from 250 to 100 000 m³/h.
- Solutions to the most complex projects.
- Wide range of modifications.
- EUROVENT and RLT certified.

VERSO and RHP selection software

- For VERSO units with capacity from 250 to 40 000 m³/h.
- For RHP units with capacity from 250 to 25 000 m³/h.
- EUROVENT and RLT certificates guarantee the accuracy of the parameters.
- Detailed technical data report.
- Generating VERSO Pro 3D models for the REVIT program.
- VERSO Standard 3D models are available in the selection software.

KOMFOVENT + BIM

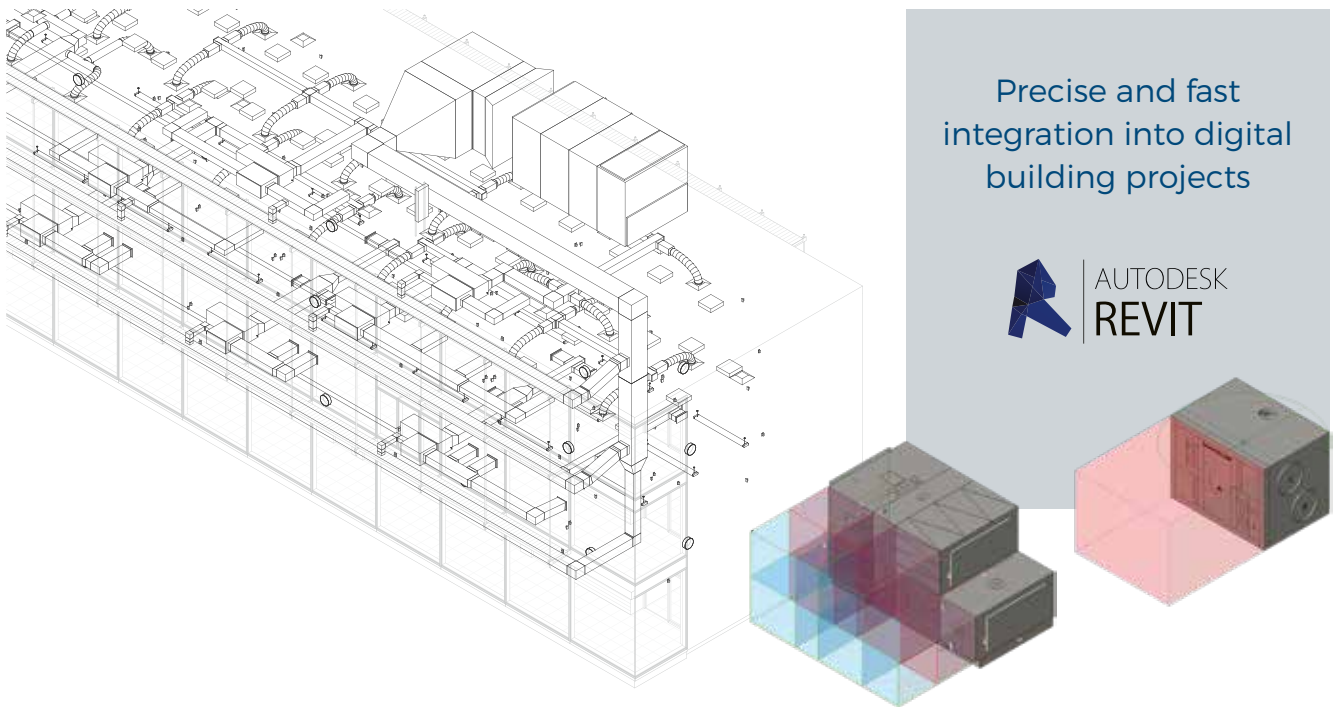

Komfovent DOMEKT + REVIT

Easy units' integration into building information modeling – 3D REVIT models of DOMEKT units are available in the REVIT add-on KOMFOVENT HUB library.

Komfovent VERSO + REVIT

Komfovent HUB – VERSO Standard digital drawings library for REVIT users. REVIT models of Komfovent VERSO Pro equipment are generated individually for each project.



VERSO Standard
3D BIM models
available
in MagiCAD Cloud
database





DOMEKT

Smart Home Comfort



Residential ventilation units with simple and intuitive control are designed to maintain the best indoor climate at home and save energy

DOMEKT features

ENERGY SAVING

- Modern energy efficient EC fans.
- High efficiency rotary and counterflow plate heat exchangers.
- Low resistance and high filtration class air filters.
- Over 20 functions optimise unit's operation and reduce running costs.

SMART CONTROL

- "Komfovent Control" app.
- Ability to control via a web browser.
- Integration into a smart home management system.
- Demand control ventilation according to the air quality parameters by connecting additional sensors.

HUMIDITY CONTROL

- Optional heat exchangers – sorption-enthalpy rotary or enthalpic counterflow plate – efficiently recover humidity.
- Air quality function ventilates premises according to the user desired humidity settings.

RELIABLE AND DURABLE CASING

- Powder coated (RAL 9003) galvanized steel panels insulated with mineral wool.
- Hydrophobic and lightweight EPP (expanded polypropylene) casing without thermal bridges and condensation is designed for several units.

LOW NOISE LEVEL

- Perfectly balanced fans.
- All of the unit's components are aerodynamically matched.
- Sound absorbing insulation and special composite materials.

LONG-LIFE SOLUTIONS

- Variable rotary heat exchanger speed control.
- Fan motors are protected from humidity and dust, and equipped with long-life bearings, IP54 protection class.
- Up to 10 safety functions, which ensure reliable operation of unit components.



Minimalist design



Plastic duct connections ensure better tightness and reduce thermal bridges

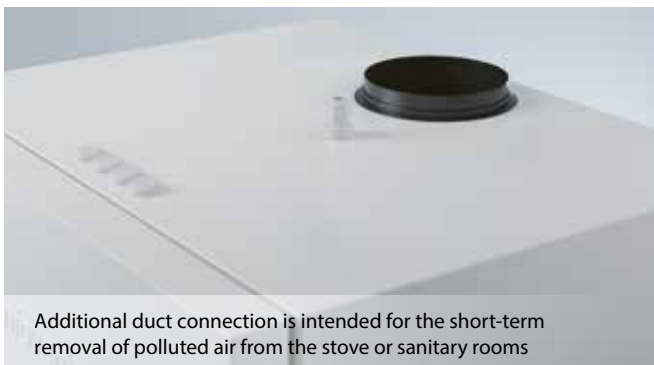

Additional duct connection is intended for the short-term removal of polluted air from the stove or sanitary rooms



Airtight doors. Locks without thermal bridges

DOMEKT
range review



Domekt R
with rotary heat exchanger

A wide selection of residential ventilation units with non-freezing rotary heat exchanger, horizontal, vertical and flat installation.

Domekt R units efficiently save energy all year round by significantly reducing both heating and air conditioning costs. Ideal for cold weather countries.

Sorption-enthalpy rotary heat exchangers maintain more comfortable indoor climate in the premises.



Domekt CF
with counterflow heat exchanger

A wide selection of residential ventilation units with counterflow plate heat exchanger, horizontal, vertical and flat installation.

Domekt CF units efficiently save energy by significantly reducing both heating and air conditioning costs especially with diffusion-enthalpy heat exchanger.

Ideal for moderate and warm climate countries.



Domekt S
supply air handling unit

Low-height false ceiling supply air units are easily installed even in the smallest premises.



Domekt R

Air handling units with rotary heat exchanger

Sizes and air volumes of Domekt R units

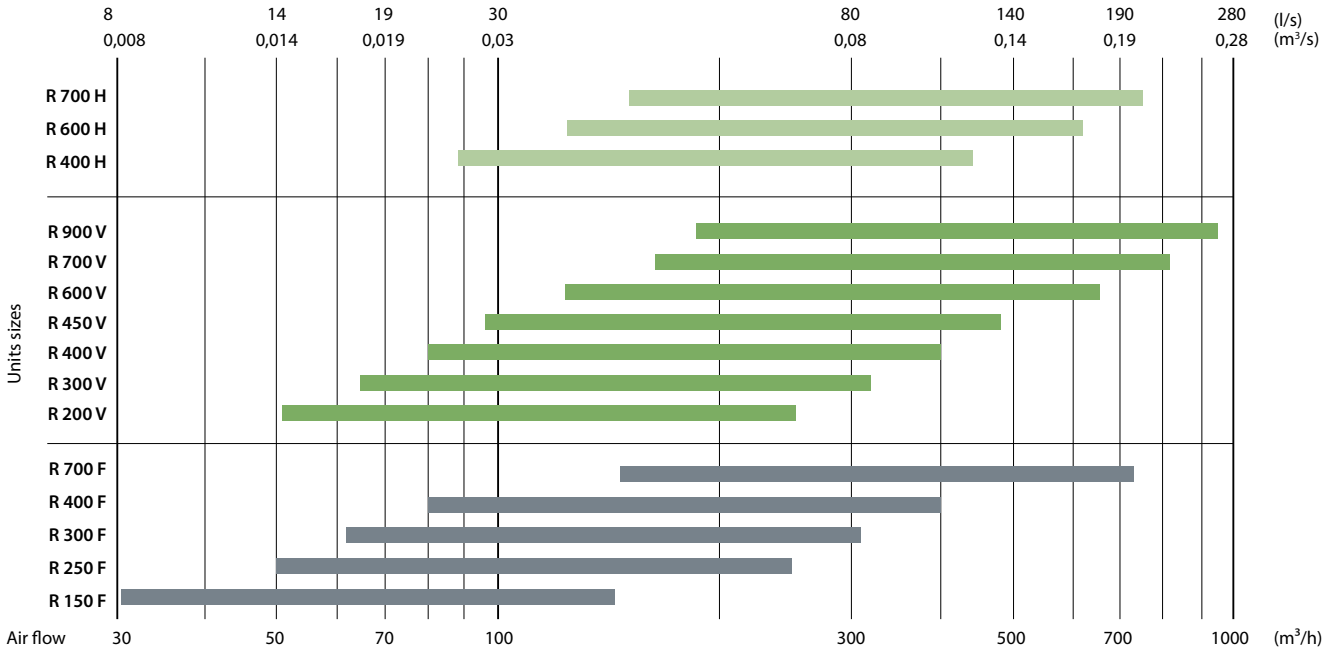

Modifications of Domekt R units

Unit	Heat exchanger		Supply/exhaust air filter class ePM1 60 % / ePM10 50 %	Heater			Cooler		Inspection side				Control system		
	Condensing L/A	Enthalpy L/AZ		HE	DH	DHCW	DHCW	HCDX	R1	R2	L1	L2	C6	C6M	C8
Domekt R 150 F	●	○	●	●	△				○	○	○	○			●
Domekt R 200 V	●		●	●	△				○		○				●
Domekt R 200 V E1	●		●	●	△				○		○				●
Domekt R 250 F	●	○	●	●	△	△	△	△	○	○	○	○	●		
Domekt R 300 V	●	○	●	●	△	△	△	△	○		○				●
Domekt R 300 F	●	○	●	●	△	△	△	△		○	○				●
Domekt R 400 V	●	○	●	●	△	△	△	△	○		○				●
Domekt R 400 H	●	○	●	●	△	△	△	△	○		○				●
Domekt R 400 F	●	○	●	●	△	△	△	△	○	○	○	○			●
Domekt R 450 V	●	○	●	●	△	△	△	△	○		○				●
Domekt R 600 V	●	○	●	●	△	△	△	△	○		○				●
Domekt R 600 H	●	○	●	●	△	△	△	△	○		○				●
Domekt R 700 V	●	○	●	●	△	△	△	△	○		○				●
Domekt R 700 H	●	○	●	●	△	△	△	△	○		○				●
Domekt R 700 F	●	○	●	●	△	△	△	△	○	○	○	○			●
Domekt R 900 V	●	○	●	●	△	△	△	△	○		○				●

● standard equipment ○ possible choice △ ordered separately duct heater/cooler The markings are explained on p. 7.

Domekt R 150 F C8

Maximal air flow, m ³ /h	150
Maximal air flow, l/s	42
Reference flow rate, m ³ /s	0,029
Reference pressure difference, Pa	50
SPI, W/(m ³ /h)	0,34
Thermal efficiency of heat recovery, %	82
Electric air heater capacity, kW / Δt, °C	0,5/13,9
Supply voltage, V	1~230
Maximal operating current HE, A	3,2
Power supply cable, mm ²	3×1,5
Electric power input of the fan drive at maximum flow rate, W	41
Electric power input of the fan drive at reference flow rate, W	17
Noise power level, L _{WA} , dB(A)	43
Noise pressure level, L _{PA} , dB(A), (3 m)	32
Filters dimensions BxHxL, mm	225×172×46
Unit dimensions BxHxL, mm	460×280×780
Maintenance space, mm	780
Unit weight, kg	29

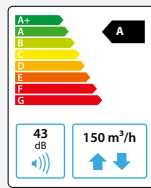

Performance

Unit with standard equipment

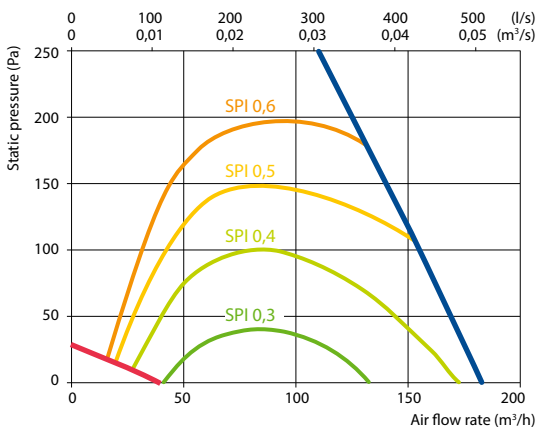

Accessories

Closing damper	AGUJ-M-160+LF230/CM230
Silencer	ODA/EHA AGS-160-50-600-M
	SUP/ETA AGS-160-50-900-M
Water heater	DH-160
PPU	PPU-HW-3R-15-0,4-W2
2-way valve (heater)	VVP47.10-0,4+SSF161.05HF
Outdoor grill	LD-160

Mounting positions

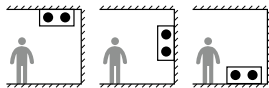

Temperature efficiency

	Winter				Summer			
Outdoor temperature, °C	-23	-15	-10	-5	0	25	30	35
After heat exchanger, °C	13,9	15,4	16,3	17,2	18,1	22,5	23,4	24,3

indoor +22 °C, 20 % RH

Shown as right (R1)
View from inspection side

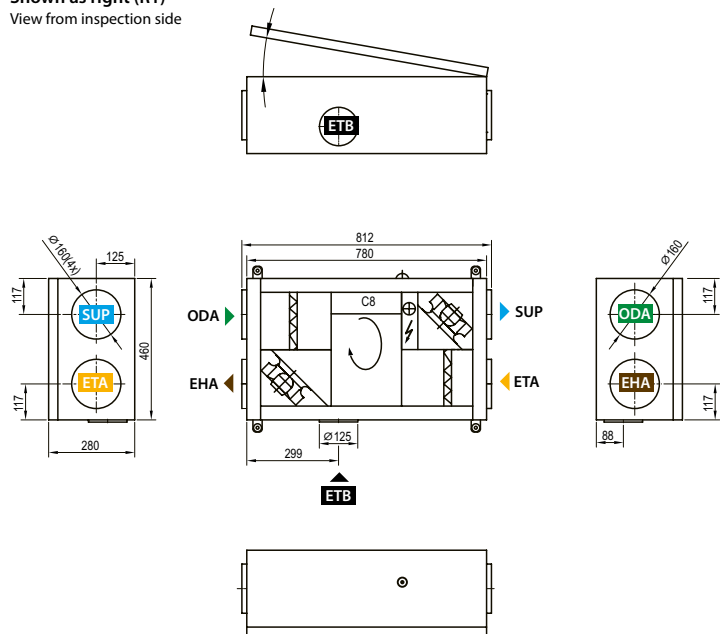

Shown as left (L1)

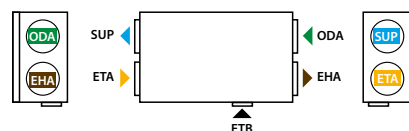

- ▶ ODA – outdoor intake
- ▶ SUP – supply air
- ▶ ETA – extract indoor
- ▶ EHA – exhaust air
- ▶ ETB – additional extraction connection (by-pass – extraction without heat recovery)

Domekt R 200 V C8

Maximal air flow, m ³ /h	233
Maximal air flow, l/s	65
Reference flow rate, m ³ /s	0,05
Reference pressure difference, Pa	50
SPI, W/(m ³ /h)	0,29
Thermal efficiency of heat recovery, %	80
Electric air heater capacity, kW / Δt, °C	0,5/8,1
Supply voltage, V	1~230
Maximal operating current HE, A	3,9
Power supply cable, mm ²	3×1,5
Electric power input of the fan drive at maximum flow rate, W	63
Electric power input of the fan drive at reference flow rate, W	23
Noise power level, L _{WA} , dB(A)	38
Noise pressure level, L _{pA} , dB(A), (3 m)	28
Filters dimensions B×H×L, mm	285×125×46
Unit dimensions B×H×L, mm	325×605×599
Maintenance space, mm	300
Unit weight, kg	39



Performance

Unit with standard equipment

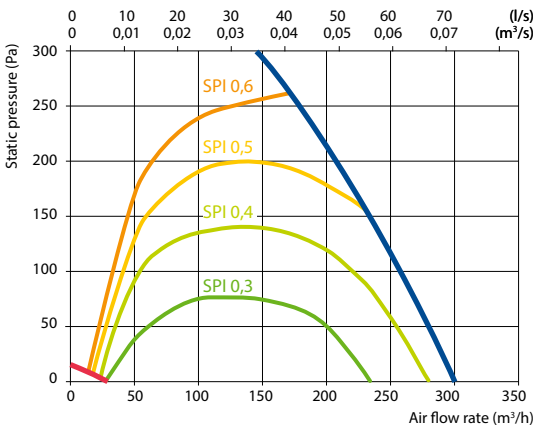

Accessories

Closing damper	AGUJ-M-125+LF230/CM230
Silencer	ODA/EHA AGS-125-50-600-M
	SUP/ETA AGS-125-50-900-M
Water heater	DH-125
PPU	PPU-HW-3R-15-0,4-W2
2-way valve (heater)	VVP47.10-0,4+SSF161.05HF
Kitchen hood	392-12
Decorative panel	392-12
Air distribution box	OSD-200VE/OSD2-200VE
Outdoor grill	LD-125

Temperature efficiency

	Winter					Summer		
Outdoor temperature, °C	-23	-15	-10	-5	0	25	30	35
After heat exchanger, °C	12,9	14,5	15,5	16,5	17,5	22,6	23,6	24,6

indoor +22 °C, 20 % RH

Shown as right (R1)

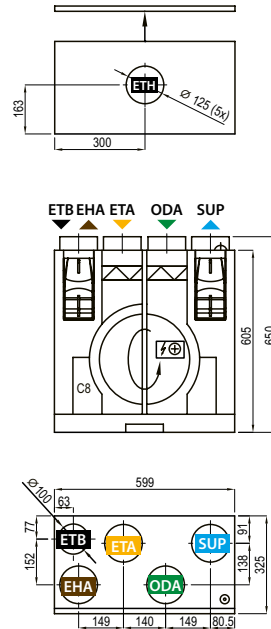

Shown as left (L1)

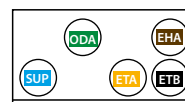

- ▶ ODA – outdoor intake
- ▶ SUP – supply air
- ▶ ETA – extract indoor
- ▶ EHA – exhaust air
- ▶ ETB – additional extraction connection (by-pass – extraction without heat recovery)
- ▶ ETH – kitchen hood connection (by-pass – extraction without heat recovery)

Domekt R 200 V C8 E1

Maximal air flow, m ³ /h	233
Maximal air flow, l/s	65
Reference flow rate, m ³ /s	0,05
Reference pressure difference, Pa	50
SPI, W/(m ³ /h)	0,29
Thermal efficiency of heat recovery, %	80
Electric air heater capacity, kW / Δt, °C	1/16,2
Supply voltage, V	1~230
Maximal operating current HE, A	6,1
Power supply cable, mm ²	3×1,5
Electric power input of the fan drive at maximum flow rate, W	63
Electric power input of the fan drive at reference flow rate, W	23
Noise power level, L _{WA} , dB(A)	38
Noise pressure level, L _{PA} , dB(A), (3 m)	28
Filters dimensions BxHxL, mm	285×125×46
Unit dimensions BxHxL, mm	325×605×599
Maintenance space, mm	300
Unit weight, kg	39



Performance

Unit with standard equipment

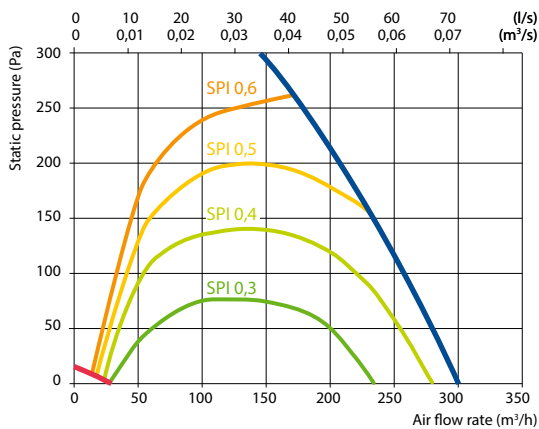

Accessories

Closing damper	AGUJ-M-125+LF230/CM230
Silencer	ODA/EHA AGS-125-50-600-M
	SUP/ETA AGS-125-50-900-M
Water heater	DH-125
PPU	PPU-HW-3R-15-0,4-W2
2-way valve (heater)	VVP47.10-0,4+SSF161.05HF
Kitchen hood	392-12
Decorative panel	392-12
Air distribution box	OSD-200VE/OSD2-200VE
Outdoor grill	LD-125

Temperature efficiency

	Winter					Summer		
Outdoor temperature, °C	-23	-15	-10	-5	0	25	30	35
After heat exchanger, °C	12,9	14,5	15,5	16,5	17,5	22,6	23,6	24,6

indoor +22 °C, 20 % RH

Shown as right (R1)

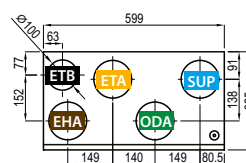
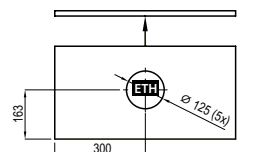

Shown as left (L1)

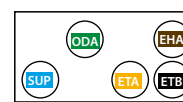

▶ ODA – outdoor intake ▶ SUP – supply air ▶ ETA – extract indoor ▶ EHA – exhaust air ▶ ETB – additional extraction connection (by-pass – extraction without heat recovery) ▶ ETH – kitchen hood connection (by-pass – extraction without heat recovery)

Domekt R 250 F C6

Maximal air flow, m ³ /h	250
Maximal air flow, l/s	69
Reference flow rate, m ³ /s	0,049
Reference pressure difference, Pa	50
SPI, W/(m ³ /h)	0,39
Thermal efficiency of heat recovery, %	80
Electric air heater capacity, kW / Δt, °C	1/16,7
Supply voltage, V	1~230
Maximal operating current HE, A	6
Power supply cable, mm ²	3×1,5
Electric power input of the fan drive at maximum flow rate, W	90
Electric power input of the fan drive at reference flow rate, W	40
Noise power level, L _{WA} , dB(A)	48
Noise pressure level, L _{PA} , dB(A), (3 m)	37
Filters dimensions B×H×L, mm	278×258×46
Unit dimensions B×H×L, mm	602×310×842
Maintenance space, mm	300
Unit weight, kg	40



Performance

Unit with standard equipment

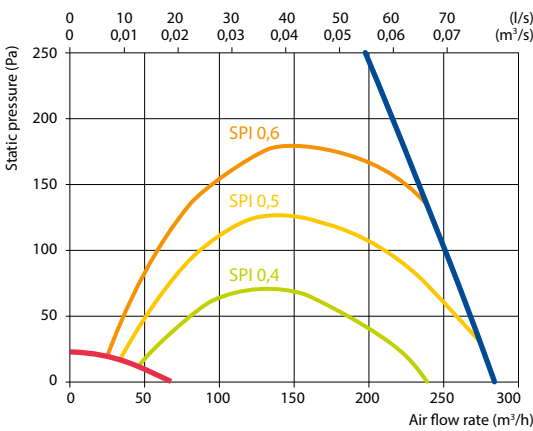

Accessories

Closing damper	AGUJ-M-160+LF230/CM230
Silencer	ODA/EHA AGS-160-50-600-M
	SUP/ETA AGS-160-50-900-M
Water heater	DH-160
PPU	PPU-HW-3R-15-0,4-W2
2-way valve (heater)	VVP47.10-0,4+SSF161.05HF
2-way valve (cooler)	VVP47.10-1,6+SSF161.05HF
Outdoor grill	LD-160
Water heater-cooler	DHCW-160

Mounting positions

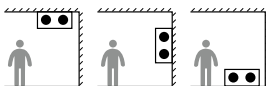

Temperature efficiency

	Winter					Summer		
Outdoor temperature, °C	-23	-15	-10	-5	0	25	30	35
After heat exchanger, °C	13	14,6	15,6	16,6	17,6	22,6	23,6	24,6

indoor +22 °C, 20 % RH

Shown as right (R2)
View from inspection side

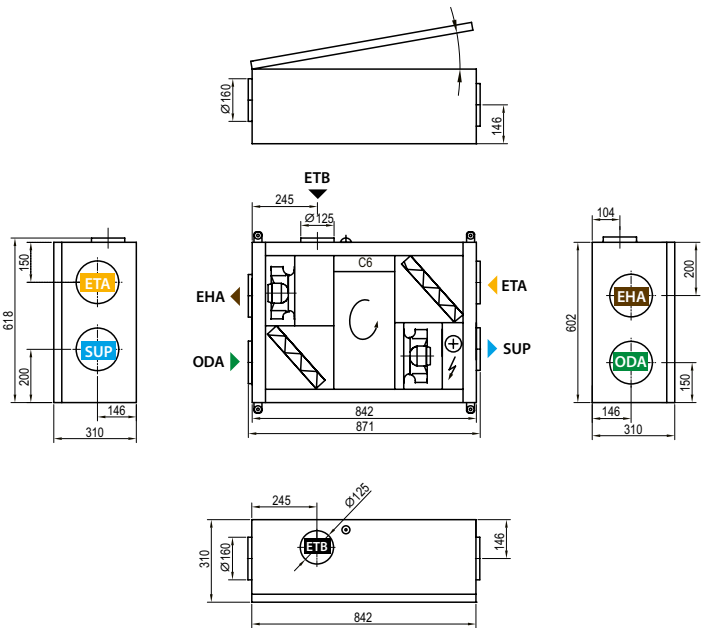

Shown as left (L2)

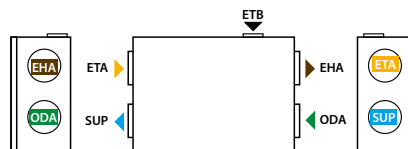

- ▶ ODA – outdoor intake
- ▶ SUP – supply air
- ▶ ETA – extract indoor
- ▶ EHA – exhaust air
- ▶ ETB – additional extraction connection (by-pass – extraction without heat recovery)

Domekt R 300 V C8

Maximal air flow, m ³ /h	311
Maximal air flow, l/s	86
Reference flow rate, m ³ /s	0,061
Reference pressure difference, Pa	50
SPI, W/(m ³ /h)	0,29
Thermal efficiency of heat recovery, %	85
Electric air heater capacity, kW / Δt, °C	0,5/6,7
Supply voltage, V	1~230
Maximal operating current HE, A	3,9
Power supply cable, mm ²	3×1,5
Electric power input of the fan drive at maximum flow rate, W	78
Electric power input of the fan drive at reference flow rate, W	34
Noise power level, L _{WA} , dB(A)	40
Noise pressure level, L _{PA} , dB(A), (3 m)	29
Filters dimensions BxHxL, mm	290×205×46
Unit dimensions BxHxL, mm	515×615×605
Maintenance space, mm	610
Unit weight, kg	29



Performance

Unit with standard equipment

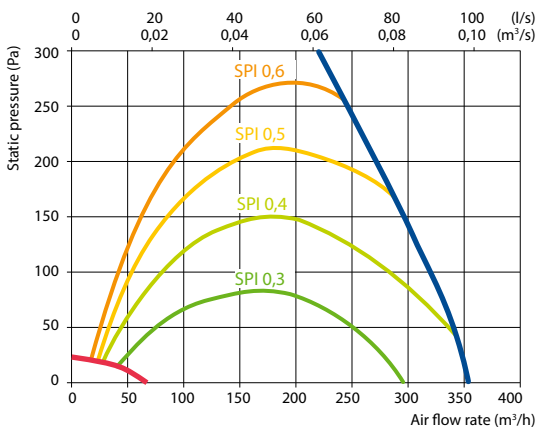

Accessories

Closing damper	AGUJ-M-160+LF230/CM230	
Silencer	ODA/EHA	AGS-160-50-600-M
	SUP/ETA	AGS-160-50-900-M
Water heater	DH-160	
PPU	PPU-HW-3R-15-0,4-W2	
2-way valve (heater)	VVP47.10-0,4+SSF161.05HF	
Water cooler	DCW-0,4-3	
2-way valve (cooler)	VVP47.10-1,6+SSF161.05HF	
Outdoor grill	LD-160	
Water heater-cooler	DHCW-160	
DX cooler	DCF-0,4-3	
Cooling unit	MOU-12HFN8a-KA8140	

Temperature efficiency

	Winter					Summer		
Outdoor temperature, °C	-23	-15	-10	-5	0	25	30	35
After heat exchanger, °C	15,3	16,5	17,2	18,0	18,7	22,5	23,2	24,0

indoor +22 °C, 20 % RH

Shown as right (R1)

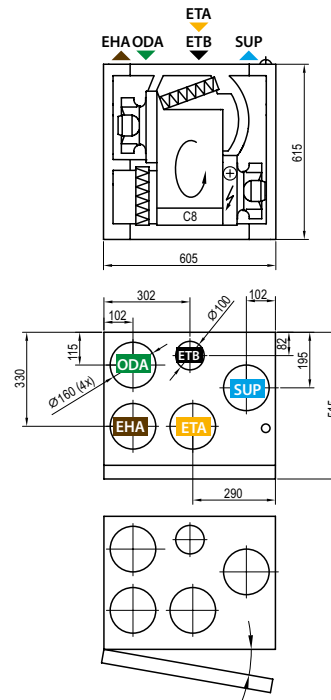

Shown as left (L1)

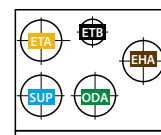

- ▶ ODA – outdoor intake
- ▶ SUP – supply air
- ▶ ETA – extract indoor
- ▶ EHA – exhaust air
- ▶ ETB – additional extraction connection (by-pass – extraction without heat recovery)

Domekt R 300 F C8

Maximal air flow, m ³ /h	288
Maximal air flow, l/s	80
Reference flow rate, m ³ /s	0,056
Reference pressure difference, Pa	50
SPI, W/(m ³ /h)	0,32
Thermal efficiency of heat recovery, %	83
Electric air heater capacity, kW / Δt, °C	1/14,5
Supply voltage, V	1~230
Maximal operating current HE, A	6,2
Power supply cable, mm ²	3×1,5
Electric power input of the fan drive at maximum flow rate, W	80
Electric power input of the fan drive at reference flow rate, W	32
Noise power level, L _{WA} , dB(A)	40
Noise pressure level, L _{pA} , dB(A), (3 m)	30
Filters dimensions B×H×L, mm	237×230×46
Unit dimensions B×H×L, mm	630×280×1090
Maintenance space, mm	300
Unit weight, kg	56



Performance

Unit with standard equipment

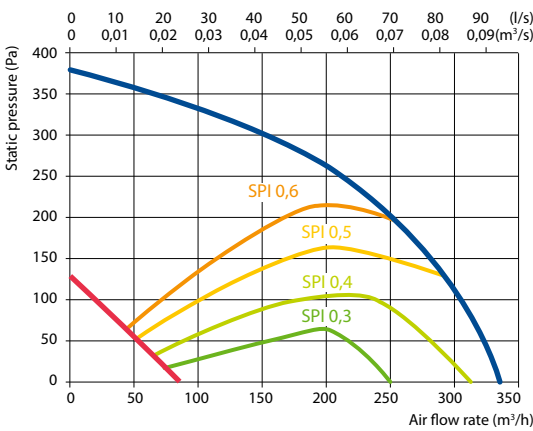

Accessories

Closing damper	AGUJ-M-160+LF230/CM230
Silencer	ODA/EHA AGS-160-50-600-M
	SUP/ETA AGS-160-50-900-M
Water heater	DH-160
PPU	PPU-HW-3R-15-0,4-W2
2-way valve (heater)	VVP47.10-0,4+SSF161.05HF
Water cooler	DCW-0,4-3
2-way valve (cooler)	VVP47.10-1,6+SSF161.05HF
Outdoor grill	LD-160
Water heater-cooler	DHCW-160
DX cooler	DCF-0,4-3
Cooling unit	MOU-12HFN8a+KA8140

Mounting positions

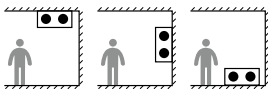

- ▶ ODA – outdoor intake
- ▶ SUP – supply air
- ▶ ETA – extract indoor
- ▶ EHA – exhaust air
- ▶ ETB – additional extraction connection (by-pass – extraction without heat recovery)

Temperature efficiency

	Winter					Summer		
Outdoor temperature, °C	-23	-15	-10	-5	0	25	30	35
After heat exchanger, °C	14,3	15,6	16,5	17,4	18,2	22,5	23,4	24,2

indoor +22 °C, 20 % RH

Shown as right (R2)
View from inspection side

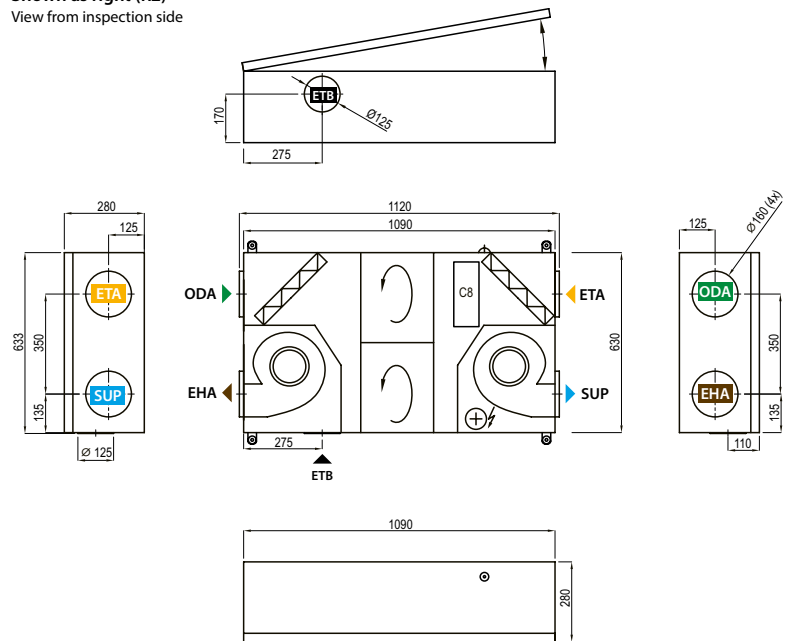

Shown as left (L1)

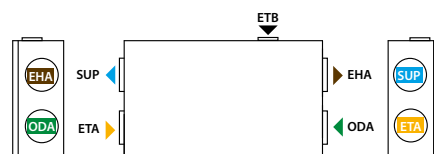

Domekt R 400 V C6M

Maximal air flow, m ³ /h	371
Maximal air flow, l/s	103
Reference flow rate, m ³ /s	0,072
Reference pressure difference, Pa	50
SPI, W/(m ³ /h)	0,3
Thermal efficiency of heat recovery, %	85
Electric air heater capacity, kW / Δt, °C	1/11,3
Supply voltage, V	1~230
Maximal operating current HE, A	6,5
Power supply cable, mm ²	3×1,5
Electric power input of the fan drive at maximum flow rate, W	114
Electric power input of the fan drive at reference flow rate, W	41
Noise power level, L _{WA} , dB(A)	37
Noise pressure level, L _{PA} , dB(A), (3 m)	27
Filters dimensions BxHxL, mm	428×231×46
Unit dimensions BxHxL, mm	495×561×598
Maintenance space, mm	600
Unit weight, kg	49



Performance

Unit with standard equipment

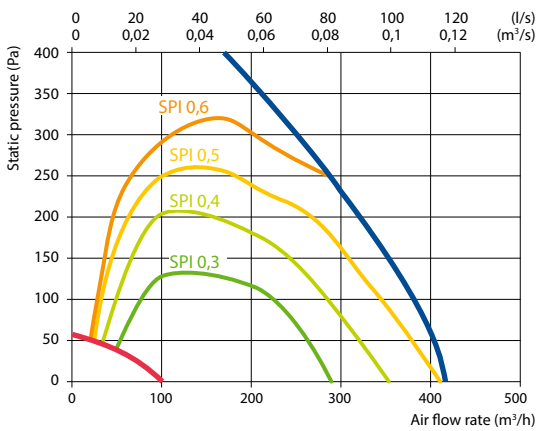

Accessories

Closing damper	AGUJ-M-160+LF230/CM230	
Silencer	ODA/EHA	AGS-160-50-600-M
	SUP/ETA	AGS-160-50-900-M
Water heater	DH-160	
PPU	PPU-HW-3R-15-0,4-W2	
2-way valve (heater)	VVP47.10-0,4+SSF161.05HF	
Water cooler	DCW-0,4-3	
2-way valve (cooler)	VVP47.10-1,6+SSF161.05HF	
Outdoor grill	LD-160	
Water heater-cooler	DHCW-160	
DX cooler	DCF-0,4-3	
Cooling unit	MOU-12HFN8a+KA8140	

Temperature efficiency

	Winter					Summer		
Outdoor temperature, °C	-23	-15	-10	-5	0	25	30	35
After heat exchanger, °C	15,3	16,5	17,2	18	18,7	22,5	23,2	24

indoor +22 °C, 20 % RH

Shown as right (R1)

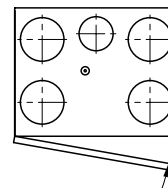
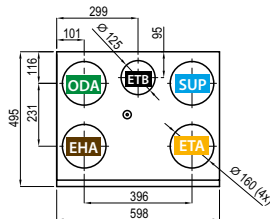
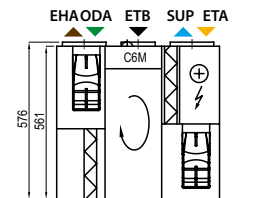

Shown as left (L1)

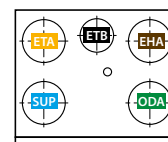

- ▶ ODA – outdoor intake
- ▶ SUP – supply air
- ▶ ETA – extract indoor
- ▶ EHA – exhaust air
- ▶ ETB – additional extraction connection (by-pass – extraction without heat recovery)

Domekt R 400 H C6M

Maximal air flow, m ³ /h	446
Maximal air flow, l/s	124
Reference flow rate, m ³ /s	0,087
Reference pressure difference, Pa	50
SPI, W/(m ³ /h)	0,27
Thermal efficiency of heat recovery, %	84
Electric air heater capacity, kW / Δt, °C	1/9,4
Supply voltage, V	1~230
Maximal operating current HE, A	7,3
Power supply cable, mm ²	3×1,5
Electric power input of the fan drive at maximum flow rate, W	112
Electric power input of the fan drive at reference flow rate, W	45
Noise power level, L _{WA} , dB(A)	45
Noise pressure level, L _{pA} , dB(A), (3 m)	34
Filters dimensions B×H×L, mm	417×210×46
Unit dimensions B×H×L, mm	515×567×660
Maintenance space, mm	650
Unit weight, kg	49



Performance

Unit with standard equipment

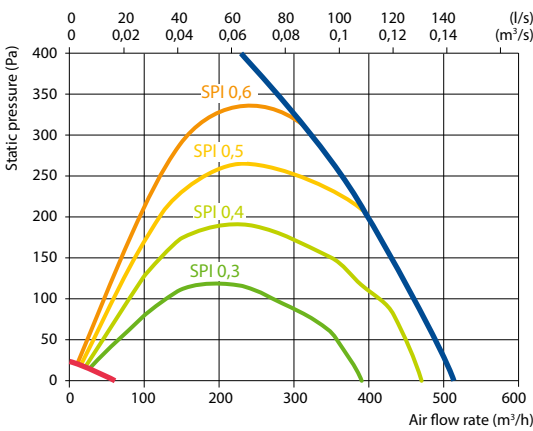

Temperature efficiency

	Winter					Summer		
Outdoor temperature, °C	-23	-15	-10	-5	0	25	30	35
After heat exchanger, °C	14,8	16,1	16,9	17,7	18,5	22,5	23,3	24,1

indoor +22 °C, 20 % RH

Shown as right (R1)

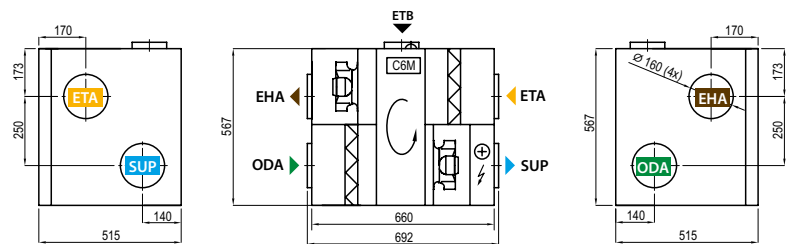

Accessories

Closing damper	AGUJ-M-160+LF230/CM230	
Silencer	ODA/EHA	AGS-160-50-600-M
	SUP/ETA	AGS-160-50-900-M
Water heater	DH-160	
PPU	PPU-HW-3R-15-0,4-W2	
2-way valve (heater)	VVP47.10-0,4+SSF161.05HF	
Water cooler	DCW-0,4-3	
2-way valve (cooler)	VVP47.10-1,6+SSF161.05HF	
Outdoor grill	LD-160	
Water heater-cooler	DHCW-160	
DX cooler	DCF-0,4-3	
Cooling unit	MOU-12HFN8a+KA8140	

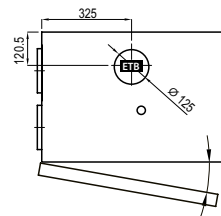

Shown as left (L1)

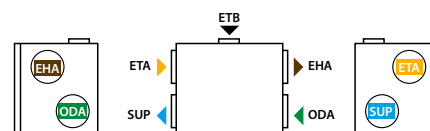

- ▶ ODA – outdoor intake
- ▶ SUP – supply air
- ▶ ETA – extract indoor
- ▶ EHA – exhaust air
- ▶ ETB – additional extraction connection (by-pass – extraction without heat recovery)

Domekt R 400 F C6M

Maximal air flow, m ³ /h	421
Maximal air flow, l/s	117
Reference flow rate, m ³ /s	0,082
Reference pressure difference, Pa	50
SPI, W/(m ³ /h)	0,26
Thermal efficiency of heat recovery, %	83
Electric air heater capacity, kW / Δt, °C	1/9,9
Supply voltage, V	1~230
Maximal operating current HE, A	7,3
Power supply cable, mm ²	3×1,5
Electric power input of the fan drive at maximum flow rate, W	84
Electric power input of the fan drive at reference flow rate, W	39
Noise power level, L _{WA} , dB(A)	45
Noise pressure level, L _{PA} , dB(A), (3 m)	33
Filters dimensions B×H×L, mm	346×258×46
Unit dimensions B×H×L, mm	700×310×1170
Maintenance space, mm	300
Unit weight, kg	65



Performance

Unit with standard equipment

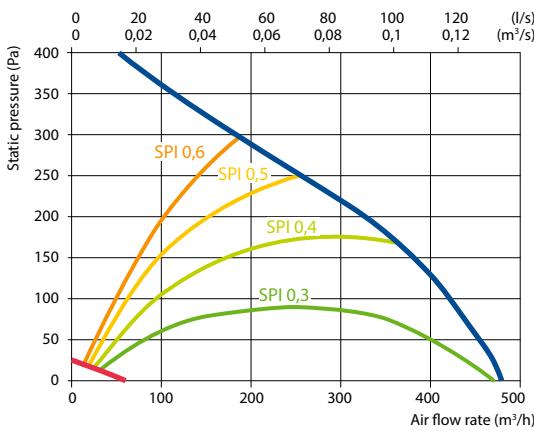

Accessories

Closing damper	AGUJ-M-200+LF230/CM230
Silencer	ODA/EHA AGS-200-50-600-M
	SUP/ETA AGS-200-50-900-M
Water heater	DH-200
PPU	PPU-HW-3R-15-0,63-W2
2-way valve (heater)	VVP47.10-0,63+SSF161.05HF
Water cooler	DCW-0,4-3
2-way valve (cooler)	VVP47.15-2,5+SSF161.05HF
Outdoor grill	LD-200
Water heater-cooler	DHCW-200
DX cooler	DCF-0,4-3
Cooling unit	MOU-12HFN8a+KA8140

Mounting positions

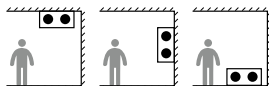

- ▶ ODA – outdoor intake
- ▶ SUP – supply air
- ▶ ETA – extract indoor
- ▶ EHA – exhaust air
- ▶ ETB – additional extraction connection (by-pass – extraction without heat recovery)

Temperature efficiency

	Winter					Summer		
Outdoor temperature, °C	-23	-15	-10	-5	0	25	30	35
After heat exchanger, °C	14,3	15,6	16,5	17,3	18,2	22,5	23,4	24,2

indoor +22 °C, 20 % RH

Shown as right (R1)
View from inspection side

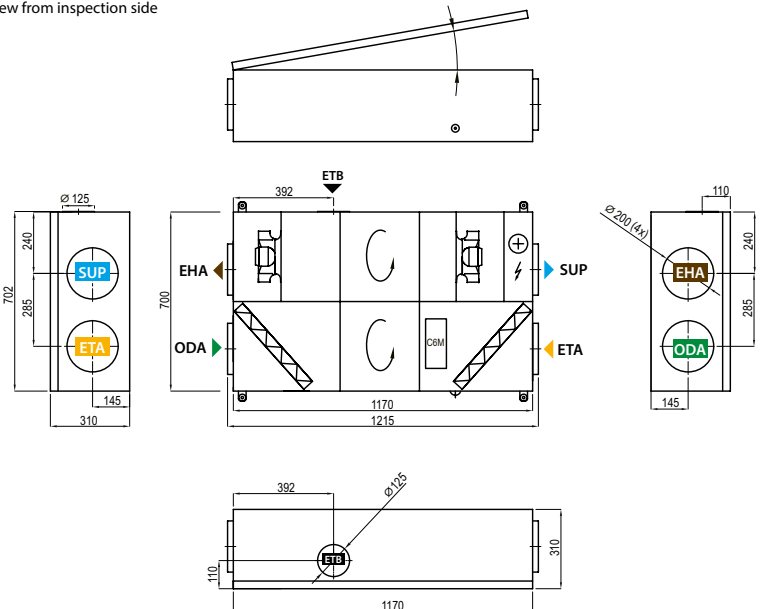

Shown as left (L1)

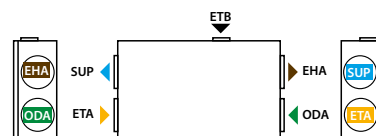

Domekt R 450 V C6M

Maximal air flow, m ³ /h	496
Maximal air flow, l/s	138
Reference flow rate, m ³ /s	0,096
Reference pressure difference, Pa	50
SPI, W/(m ³ /h)	0,3
Thermal efficiency of heat recovery, %	86
Electric air heater capacity, kW / Δt, °C	1/8,5
Supply voltage, V	1~230
Maximal operating current HE, A	7,5
Power supply cable, mm ²	3×1,5
Electric power input of the fan drive at maximum flow rate, W	147
Electric power input of the fan drive at reference flow rate, W	55
Noise power level, L _{WA} , dB(A)	38
Noise pressure level, L _{pA} , dB(A), (3 m)	28
Filters dimensions B×H×L, mm	517×278×46
Unit dimensions B×H×L, mm	585×655×680
Maintenance space, mm	700
Unit weight, kg	60



Performance

Unit with standard equipment

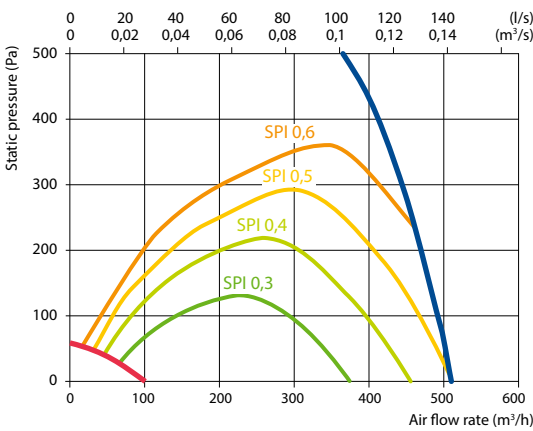

Accessories

Closing damper	AGUJ-M-160+LF230/CM230
Silencer	ODA/EHA AGS-160-50-600-M
	SUP/ETA AGS-160-50-900-M
Water heater	DH-160
PPU	PPU-HW-3R-15-0,4-W2
2-way valve (heater)	VVP47.10-0,4+SSF161.05HF
Water cooler	DCW-0,5-3
2-way valve (cooler)	VVP47.10-1,6+SSF161.05HF
Outdoor grill	LD-160
Water heater-cooler	DHCW-160
DX cooler	DCF-0,5-3
Cooling unit	MOU-12HFN8a+KA8140

Temperature efficiency

	Winter					Summer		
Outdoor temperature, °C	-23	-15	-10	-5	0	25	30	35
After heat exchanger, °C	15,7	16,8	17,5	18,2	18,9	22,4	23,1	23,8

indoor +22 °C, 20 % RH

Shown as right (R1)

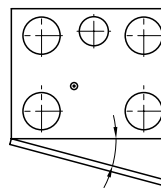
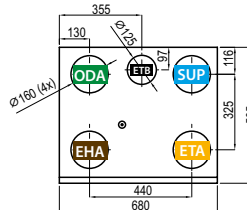
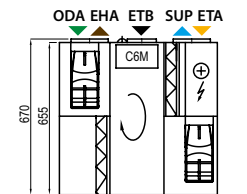

Shown as left (L1)

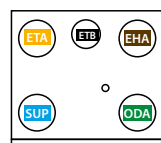

- ▶ ODA – outdoor intake
- ▶ SUP – supply air
- ▶ ETA – extract indoor
- ▶ EHA – exhaust air
- ▶ ETB – additional extraction connection (by-pass – extraction without heat recovery)

Domekt R 600 V C6M

Maximal air flow, m ³ /h	669
Maximal air flow, l/s	186
Reference flow rate, m ³ /s	0,130
Reference pressure difference, Pa	50
SPI, W/(m ³ /h)	0,25
Thermal efficiency of heat recovery, %	84
Electric air heater capacity, kW / Δt, °C	1,5/8,9
Supply voltage, V	1~230
Maximal operating current HE, A	9,5
Power supply cable, mm ²	3×1,5
Electric power input of the fan drive at maximum flow rate, W	167
Electric power input of the fan drive at reference flow rate, W	59
Noise power level, L _{WA} , dB(A)	44
Noise pressure level, L _{PA} , dB(A), (3 m)	32
Filters dimensions BxHxL, mm	515×240×46
Unit dimensions BxHxL, mm	905×750×610
Maintenance space, mm	900
Unit weight, kg	82



Performance

Unit with standard equipment

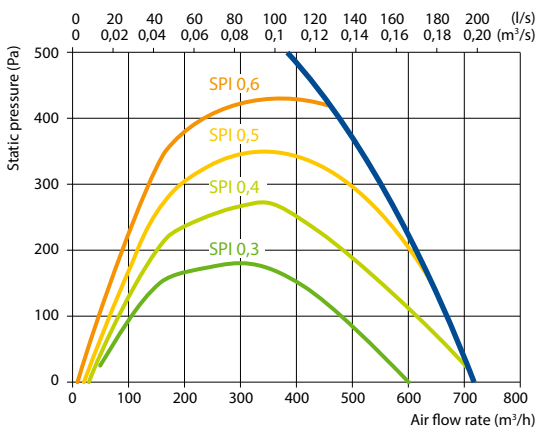

Accessories

Closing damper	AGUJ-M-200+LF230/CM230
Silencer	ODA/EHA AGS-200-50-600-M
	SUP/ETA AGS-200-50-900-M
Water heater	DH-200
PPU	PPU-HW-3R-15-0,63-W2
2-way valve (heater)	VVP47.15-2,5+SSF161.05HF
Water cooler	DCW-0,5-3
2-way valve (cooler)	VVP47.15-2,5+SSF161.05HF
Outdoor grill	LD-200
Water heater-cooler	DHCW-250
DX cooler	DCF-0,5-3
Cooling unit	MOU-12HFN8a+KA8140

Temperature efficiency

	Winter				Summer			
Outdoor temperature, °C	-23	-15	-10	-5	0	25	30	35
After heat exchanger, °C	14,8	16,1	16,9	17,7	18,5	22,5	23,2	24,1

indoor +22 °C, 20 % RH

Shown as right (R1)

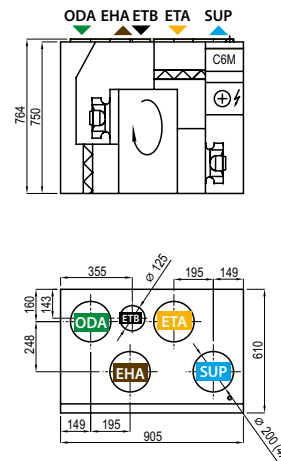

Shown as left (L1)

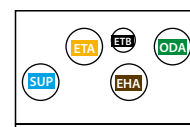
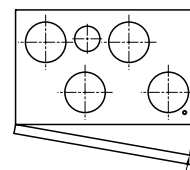

- ▶ ODA – outdoor intake
- ▶ SUP – supply air
- ▶ ETA – extract indoor
- ▶ EHA – exhaust air
- ▶ ETB – additional extraction connection (by-pass – extraction without heat recovery)

Domekt R 600 H C6M

Maximal air flow, m ³ /h	650
Maximal air flow, l/s	181
Reference flow rate, m ³ /s	0,126
Reference pressure difference, Pa	50
SPI, W/(m ³ /h)	0,26
Thermal efficiency of heat recovery, %	83
Electric air heater capacity, kW / Δt, °C	1/6,4
Supply voltage, V	1~230
Maximal operating current HE, A	7,3
Power supply cable, mm ²	3×1,5
Electric power input of the fan drive at maximum flow rate, W	158
Electric power input of the fan drive at reference flow rate, W	62
Noise power level, L _{WA} , dB(A)	44
Noise pressure level, L _{pA} , dB(A), (3 m)	33
Filters dimensions B×H×L, mm	475×235×46
Unit dimensions B×H×L, mm	570×600×1060
Maintenance space, mm	1100
Unit weight, kg	80



Performance

Unit with standard equipment

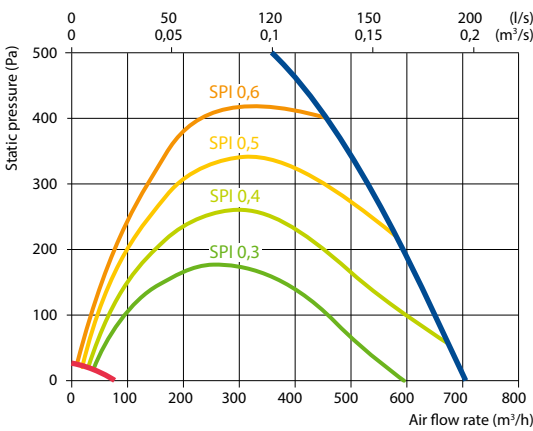

Temperature efficiency

	Winter					Summer		
Outdoor temperature, °C	-23	-15	-10	-5	0	25	30	35
After heat exchanger, °C	14,4	15,7	16,6	17,4	18,3	22,5	23,4	24,2

indoor +22 °C, 20 % RH

Shown as right (R1)

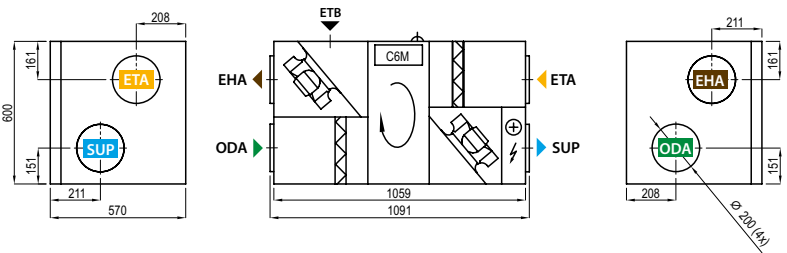

Accessories

Closing damper	AGUJ-M-200+LF230/CM230
Silencer	ODA/EHA AGS-200-50-600-M
	SUP/ETA AGS-200-50-900-M
Water heater	DH-200
PPU	PPU-HW-3R-15-0,63-W2
2-way valve (heater)	VVP47.10-0,63+SSF161.05HF
Water cooler	DCW-0,7-5
2-way valve (cooler)	VVP47.10-0,63+SSF161.05HF
Outdoor grill	LD-200
Water heater-cooler	DHCW-200
DX cooler	DCF-0,7-5
Cooling unit	MOU-18HFN8a+KA8140

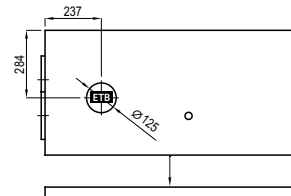

Shown as left (L1)



- ▶ ODA – outdoor intake
- ▶ SUP – supply air
- ▶ ETA – extract indoor
- ▶ EHA – exhaust air
- ▶ ETB – additional extraction connection (by-pass – extraction without heat recovery)

Domekt R 700 V C6M

Maximal air flow, m ³ /h	738
Maximal air flow, l/s	205
Reference flow rate, m ³ /s	0,140
Reference pressure difference, Pa	50
SPI, W/(m ³ /h)	0,26
Thermal efficiency of heat recovery, %	84
Electric air heater capacity, kW / Δt, °C	2/11,6
Supply voltage, V	1~230
Maximal operating current HE, A	11,6
Power supply cable, mm ²	3×1,5
Electric power input of the fan drive at maximum flow rate, W	178
Electric power input of the fan drive at reference flow rate, W	76
Noise power level, L _{WA} , dB(A)	44
Noise pressure level, L _{PA} , dB(A), (3 m)	33
Filters dimensions BxHxL, mm	540×260×46
Unit dimensions BxHxL, mm	637×950×1070
Maintenance space, mm	1070
Unit weight, kg	110



Performance

Unit with standard equipment

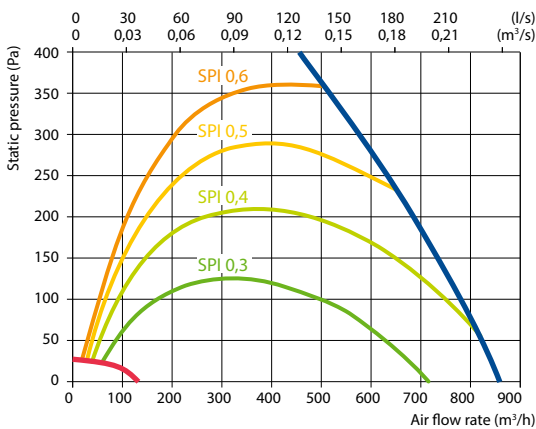

Accessories

Closing damper	AGUJ-M-250+LF230/CM230
Silencer	ODA/EHA AGS-250-50-600-M
	SUP/ETA AGS-250-50-900-M
Water heater	DH-250
PPU	PPU-HW-3R-15-0,63-W2
2-way valve (heater)	VVP47.10-0,63+SSF161.05HF
Water cooler	DCW-0,7-5
2-way valve (cooler)	VVP47.15-2,5+SSF161.05HF
Outdoor grill	LD-250
Water heater-cooler	DHCW-250
DX cooler	DCF-0,7-5
Cooling unit	MOU-18HFN8a+KA8140

Temperature efficiency

	Winter				Summer			
Outdoor temperature, °C	-23	-15	-10	-5	0	25	30	35
After heat exchanger, °C	14,7	16,0	16,8	17,6	18,4	22,5	23,3	24,1

indoor +22 °C, 20 % RH

Shown as right (R1)

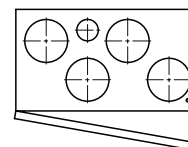
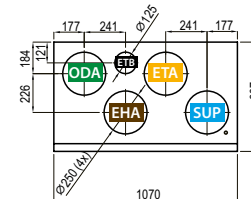

Shown as left (L1)

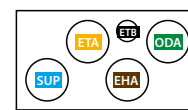

- ▶ ODA – outdoor intake
- ▶ SUP – supply air
- ▶ ETA – extract indoor
- ▶ EHA – exhaust air
- ▶ ETB – additional extraction connection (by-pass – extraction without heat recovery)

Domekt R 700 H C6M

Maximal air flow, m ³ /h	742
Maximal air flow, l/s	206
Reference flow rate, m ³ /s	0,144
Reference pressure difference, Pa	50
SPI, W/(m ³ /h)	0,26
Thermal efficiency of heat recovery, %	84
Electric air heater capacity, kW / Δt, °C	2/11,3
Supply voltage, V	1~230
Maximal operating current HE, A	11,7
Power supply cable, mm ²	3×1,5
Electric power input of the fan drive at maximum flow rate, W	179
Electric power input of the fan drive at reference flow rate, W	73
Noise power level, L _{WA} , dB(A)	46
Noise pressure level, L _{pA} , dB(A), (3 m)	35
Filters dimensions B×H×L, mm	540×260×46
Unit dimensions B×H×L, mm	634×700×930
Maintenance space, mm	950
Unit weight, kg	83



Performance

Unit with standard equipment

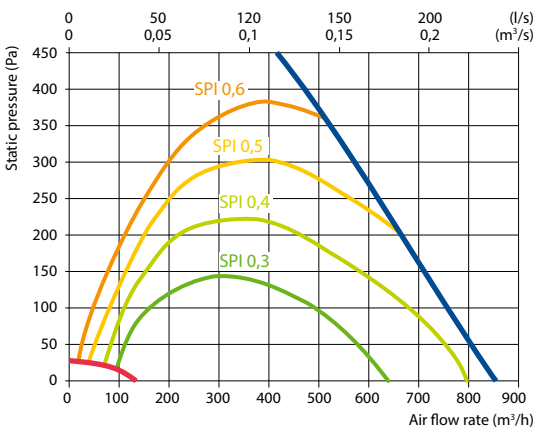

Temperature efficiency

	Winter					Summer		
Outdoor temperature, °C	-23	-15	-10	-5	0	25	30	35
After heat exchanger, °C	14,8	16,1	16,9	17,7	18,5	22,5	23,3	24,1

indoor +22 °C, 20 % RH

Shown as right (R1)

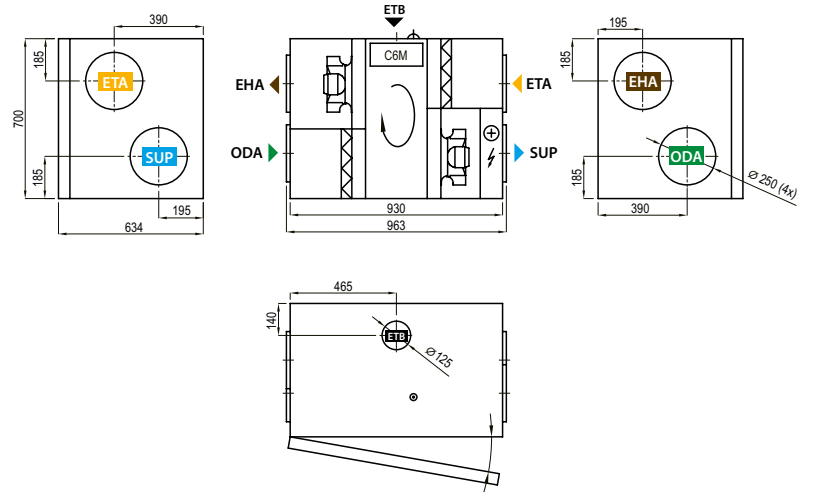

Accessories

Closing damper	AGUJ-M-250+LF230/CM230
Silencer	ODA/EHA AGS-250-50-600-M
	SUP/ETA AGS-250-50-900-M
Water heater	DH-250
PPU	PPU-HW-3R-15-0,63-W2
2-way valve (heater)	VVP47.10-0,63+SSF161.05HF
Water cooler	DCW-0,7-5
2-way valve (cooler)	VVP47.15-2,5+SSF161.05HF
Outdoor grill	LD-250
Water heater-cooler	DHCW-250
DX cooler	DCF-0,7-5
Cooling unit	MOU-18HFN8a+KA8140

Shown as left (L1)

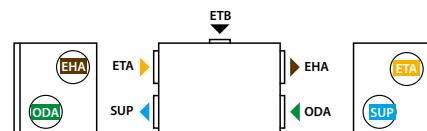

- ▶ ODA – outdoor intake
- ▶ SUP – supply air
- ▶ ETA – extract indoor
- ▶ EHA – exhaust air
- ▶ ETB – additional extraction connection (by-pass – extraction without heat recovery)

Domekt R 700 F C6M

Maximal air flow, m ³ /h	707
Maximal air flow, l/s	196
Reference flow rate, m ³ /s	0,138
Reference pressure difference, Pa	50
SPI, W/(m ³ /h)	0,25
Thermal efficiency of heat recovery, %	83
Electric air heater capacity, kW / Δt, °C	2/11,8
Supply voltage, V	1~230
Maximal operating current HE, A	11,7
Power supply cable, mm ²	3×1,5
Electric power input of the fan drive at maximum flow rate, W	156
Electric power input of the fan drive at reference flow rate, W	67
Noise power level, L _{WA} , dB(A)	46
Noise pressure level, L _{PA} , dB(A), (3 m)	34
Filters dimensions BxHxL, mm	368×375×46
Unit dimensions BxHxL, mm	850×420×1240
Maintenance space, mm	500
Unit weight, kg	93



Performance

Unit with standard equipment

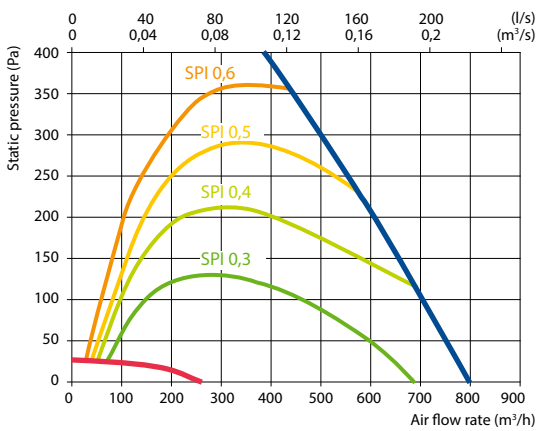

Accessories

Closing damper	AGUJ-M-250+LF230/CM230
Silencer	ODA/EHA AGS-250-50-600-M
	SUP/ETA AGS-250-50-900-M
Water heater	DH-250
PPU	PPU-HW-3R-15-0,63-W2
2-way valve (heater)	VVP47.10-0,63+SSF161.05HF
Water cooler	DCW-0,7-5
2-way valve (cooler)	VVP47.15-2,5+SSF161.05HF
Outdoor grill	LD-250
Water heater-cooler	DHCW-250
DX cooler	DCF-0,7-5
Cooling unit	MOU-18HFN8a+KA8140

Mounting positions

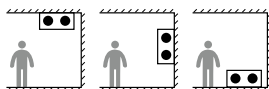

Temperature efficiency

	Winter					Summer		
Outdoor temperature, °C	-23	-15	-10	-5	0	25	30	35
After heat exchanger, °C	14,2	15,6	16,5	17,3	18,2	22,5	23,4	24,2

indoor +22 °C, 20 % RH

Shown as right (R1)
View from inspection side

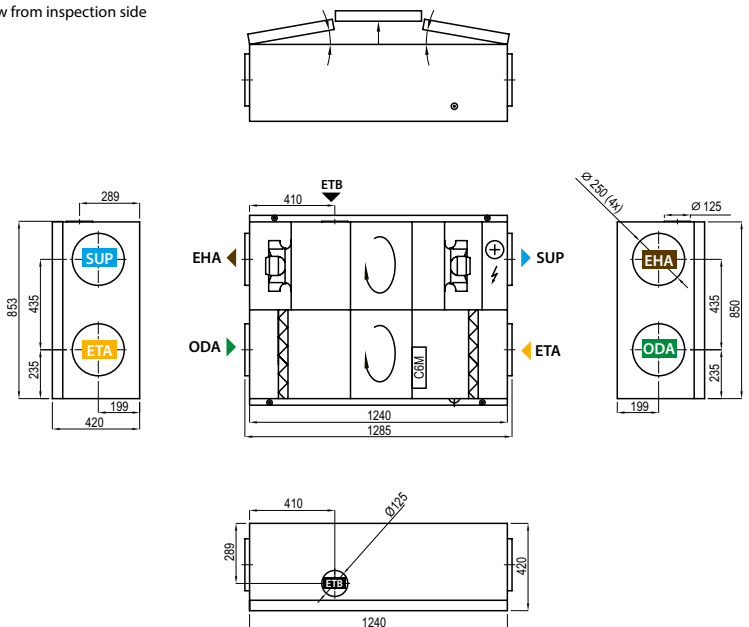

Shown as left (L1)

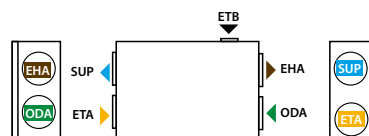

- ▶ ODA – outdoor intake
- ▶ SUP – supply air
- ▶ ETA – extract indoor
- ▶ EHA – exhaust air
- ▶ ETB – additional extraction connection (by-pass – extraction without heat recovery)

Domekt R 900 V C6M

Maximal air flow, m ³ /h	995
Maximal air flow, l/s	276
Reference flow rate, m ³ /s	0,194
Reference pressure difference, Pa	50
SPI, W/(m ³ /h)	0,31
Thermal efficiency of heat recovery, %	81
Electric air heater capacity, kW / Δt, °C	2/8,4
Supply voltage, V	1~230
Maximal operating current HE, A	13,8
Power supply cable, mm ²	3×1,5
Electric power input of the fan drive at maximum flow rate, W	261
Electric power input of the fan drive at reference flow rate, W	125
Noise power level, L _{WA,r} dB(A)	46
Noise pressure level, L _{PA,r} dB(A), (3 m)	36
Filters dimensions B×H×L, mm	540×260×46
Unit dimensions B×H×L, mm	637×950×1070
Maintenance space, mm	1070
Unit weight, kg	110



Performance

Unit with standard equipment

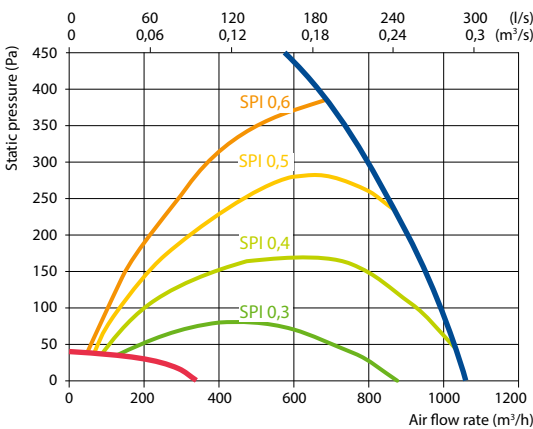

Accessories

Closing damper	AGUJ-M-250+LF230/CM230
Silencer	ODA/EHA AGS-250-50-900-M
	SUP/ETA AGS-250-50-1200-M
Water heater	DH-250
PPU	PPU-HW-3R-15-0,63-W2
2-way valve (heater)	VVP47.10-0,63+SSF161.05HF
Water cooler	DCW-0,9-6
2-way valve (cooler)	VVP47.15-2,5+SSF161.05HF
Outdoor grill	LD-250
Water heater-cooler	DHCW-315
DX cooler	DCF-0,9-6
Cooling unit	MOU-18HFN8a+KA8140

Temperature efficiency

	Winter					Summer		
Outdoor temperature, °C	-23	-15	-10	-5	0	25	30	35
After heat exchanger, °C	13,6	15,1	16,0	16,9	17,9	22,6	23,5	24,4

indoor +22 °C, 20 % RH

Shown as right (R1)

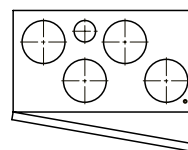
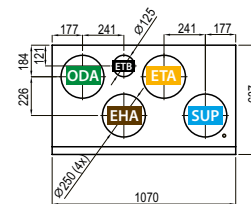
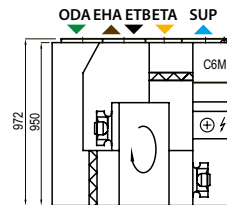

Shown as left (L1)

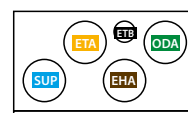

- ▶ ODA – outdoor intake
- ▶ SUP – supply air
- ▶ ETA – extract indoor
- ▶ EHA – exhaust air
- ▶ ETB – additional extraction connection (by-pass – extraction without heat recovery)

Domekt CF

Air handling units with counterflow plate heat exchangers

Sizes and air volumes of Domekt CF units

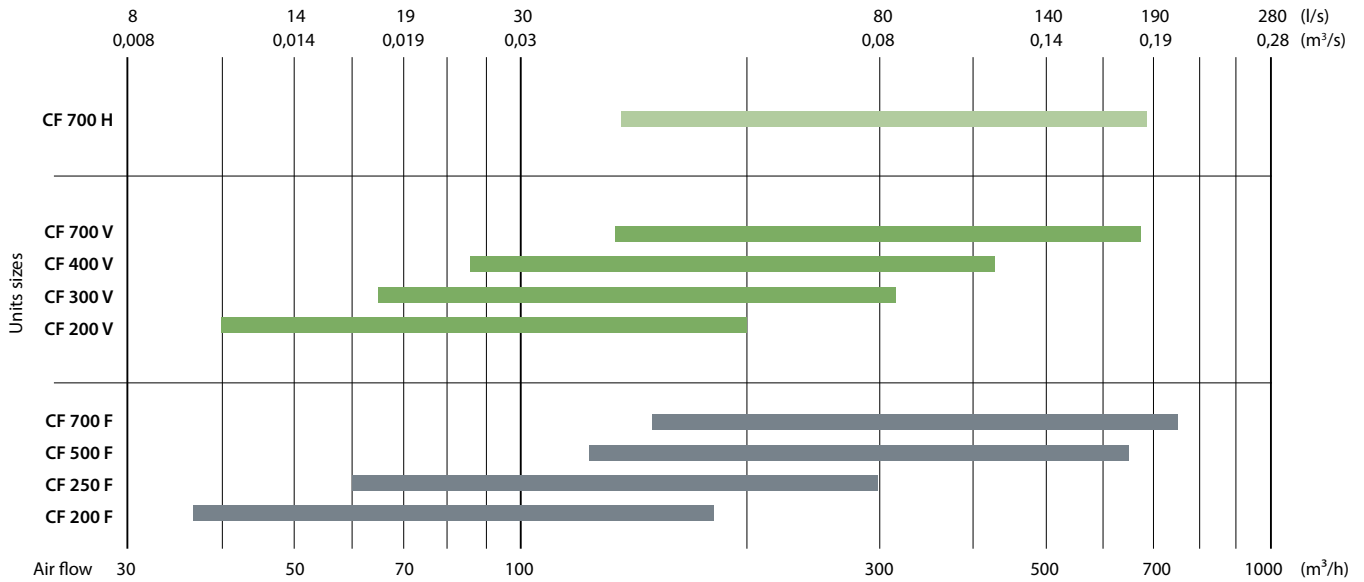

Modifications of Domekt CF units

Unit	Heat exchanger		Supply/exhaust air filter class ePM1 60 % / ePM10 50 %	Preheater	Heater			Cooler		Inspection side				Bypass	Control system		
	Condensing	Enthalpy		HE	HE	DH	DHCW	DHCW	HCDX	R1	R2	L1	L2	Inner	C6	C6M	C8
Domekt CF 200 F	●	○	●	△	●	△					○	○		●			●
Domekt CF 200 V	●	○	●	●	●	△				○		○		●			●
Domekt CF 250 F	●	○	●	●	●	△	△	△		○	○	○	○	●	●		
Domekt CF 300 V	●	○	●	●	●	△	△	△	△	○		○		●			●
Domekt CF 400 V	●	○	●	●	●	△	△	△	△	○		○		●			●
Domekt CF 500 F	●	○	●	●	●	△	△	△	△	○	○	○	○	●			●
Domekt CF 700 V	●	○	●	●	●	△	△	△	△	○		○		●			●
Domekt CF 700 H	●	○	●	●	●	△	△	△	△	○		○		●			●
Domekt CF 700 F	●		●	●	●	△	△	△	△	○	○	○	○	●			●

● standard equipment ○ possible choice △ ordered separately duct heater/cooler

The markings are explained on p. 7.

Domekt CF 200 F C8

Maximal air flow, m ³ /h	181
Maximal air flow, l/s	50
Reference flow rate, m ³ /s	0,035
Reference pressure difference, Pa	50
SPI, W/(m ³ /h)	0,21
Thermal efficiency of heat recovery, %	88
Electric air heater capacity, kW / Δt, °C	0,5/11,5
Supply voltage, V	1~230
Maximal operating current HE, A	3,2
Power supply cable, mm ²	3×1,5
Electric power input of the fan drive at maximum flow rate, W	41
Electric power input of the fan drive at reference flow rate, W	13
Noise power level, L _{WA,r} dB(A)	41
Noise pressure level, L _{pA,r} dB(A), (3 m)	31
Filters dimensions B×H×L, mm	250×232×46
Unit dimensions B×H×L, mm	560×294×1100
Maintenance space, mm	300
Unit weight, kg	28



Performance

Unit with standard equipment

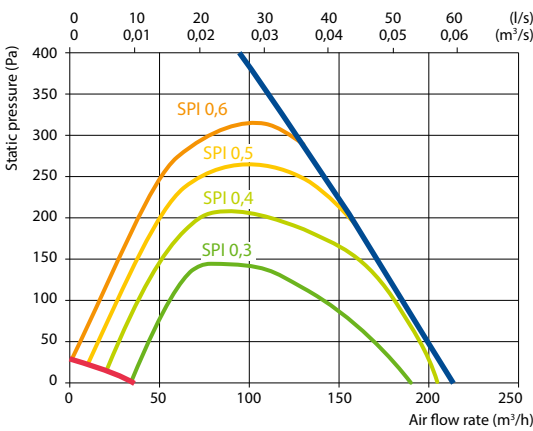

Accessories

Closing damper	AGUJ-M-160+LF230/CM230
Silencer	ODA/EHA AGS-160-50-600-M SUP/ETA AGS-160-50-900-M
Water heater	DH-160
PPU	PPU-HW-3R-15-0,4-W2
2-way valve (heater)	VVP47.10-0,25+SSF161.05HF
Outdoor grill	LD-160

Mounting positions



Temperature efficiency

	Winter					Summer		
Outdoor temperature, °C	-23	-15	-10	-5	0	25	30	35
After heat exchanger, °C	17,4	18	18,4	18,8	19,4	22,4	22,9	23,5

indoor +22 °C, 20 % RH

Shown as right (R2)
View from inspection side

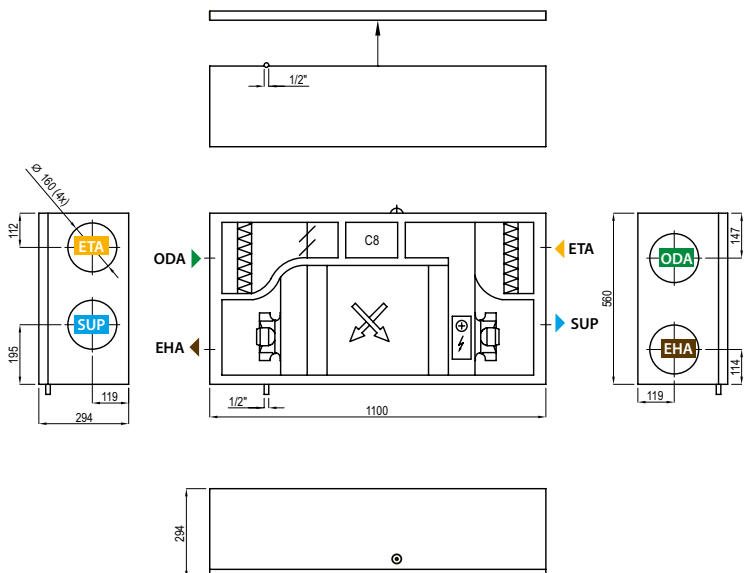

Shown as left (L1)



▶ ODA – outdoor intake ▶ SUP – supply air ▶ ETA – extract indoor ▶ EHA – exhaust air

Domekt CF 200 V C6M

Maximal air flow, m ³ /h	199
Maximal air flow, l/s	55
Reference flow rate, m ³ /s	0,039
Reference pressure difference, Pa	50
SPI, W/(m ³ /h)	0,21
Thermal efficiency of heat recovery, %	92
Electric air heater capacity, kW / Δt, °C	0,5/10,5
Electric preheater capacity, kW / Δt, °C	1/21
Supply voltage, V	1~230
Maximal operating current HE, A	8,3
Power supply cable, mm ²	3×1,5
Electric power input of the fan drive at maximum flow rate, W	37
Electric power input of the fan drive at reference flow rate, W	16
Noise power level, L _{WA} , dB(A)	40
Noise pressure level, L _{PA} , dB(A), (3 m)	29
Filters dimensions B×H×L, mm	365×132×46
Unit dimensions B×H×L, mm	630×790×595
Maintenance space, mm	600
Unit weight, kg	42



Performance

Unit with standard equipment

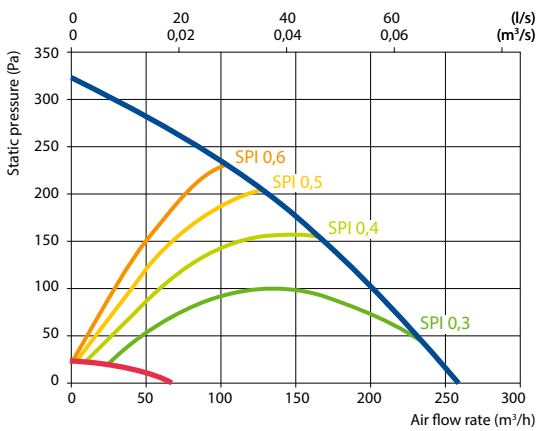

Accessories

Closing damper	AGUJ-M-160+LF230/CM230
Silencer	ODA/EHA AGS-160-50-600-M
	SUP/ETA AGS-160-50-900-M
Water heater	DH-160
PPU	PPU-HW-3R-15-0,4-W2
2-way valve (heater)	VVP47.10-0,25+SSF161.05HF
Outdoor grill	LD-160

Temperature efficiency

Outdoor temperature, °C	Winter				Summer			
	-23	-15	-10	-5	0	25	30	35
After heat exchanger*, °C	18,9*	19,0*	19,0*	19,0*	19,6	22,3	22,9	23,4

indoor +22 °C, 20 % RH

* calculations made after evaluation of the preheater.

Shown as right (R1)

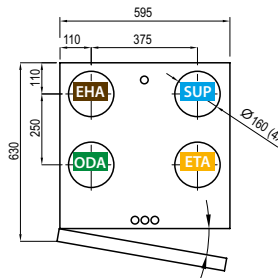
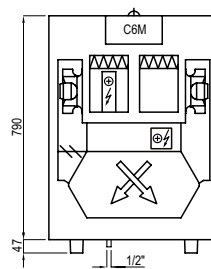

Shown as left (L1)

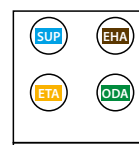

▶ ODA – outdoor intake ▶ SUP – supply air ▶ ETA – extract indoor ▶ EHA – exhaust air

Domekt CF 250 F C6

Maximal air flow, m ³ /h	292
Maximal air flow, l/s	81
Reference flow rate, m ³ /s	0,057
Reference pressure difference, Pa	50
SPI, W/(m ³ /h)	0,29
Thermal efficiency of heat recovery, %	86
Electric air heater capacity, kW / Δt, °C	0,5/7,1
Electric preheater capacity, kW / Δt, °C	1/14,3
Supply voltage, V	1~230
Maximal operating current HE, A	8,2
Power supply cable, mm ²	3×1,5
Electric power input of the fan drive at maximum flow rate, W	91
Electric power input of the fan drive at reference flow rate, W	33
Noise power level, L _{WA} , dB(A)	46
Noise pressure level, L _{PA} , dB(A), (3 m)	35
Filters dimensions B×H×L, mm	265×250×46
Unit dimensions B×H×L, mm	604×294×1250
Maintenance space, mm	300
Unit weight, kg	52



Performance

Unit with standard equipment

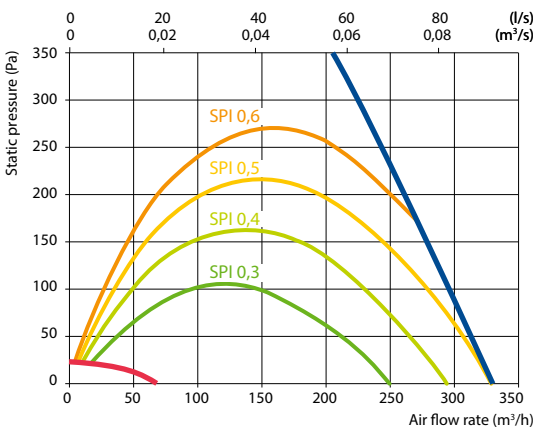

Accessories

Closing damper	AGUJ-M-160+LF230/CM230
Silencer	ODA/EHA AGS-160-50-600-M
	SUP/ETA AGS-160-50-900-M
Water heater	DH-160
PPU	PPU-HW-3R-15-0,4-W2
2-way valve (heater)	VVP47.10-0,4+SSF161.05HF
2-way valve (cooler)	VVP47.10-1,6+SSF161.05HF
Outdoor grill	LD-160
Water heater-cooler	DHCW-160

Mounting positions



Temperature efficiency

Outdoor temperature, °C	Winter					Summer		
	-23	-15	-10	-5	0	25	30	35
After heat exchanger*, °C	18*	18,9*	18,9*	18,9*	18,9	22,4	23,1	23,8

indoor +22 °C, 20 % RH

* calculations made after evaluation of the preheater.

Shown as right (R1)

View from inspection side

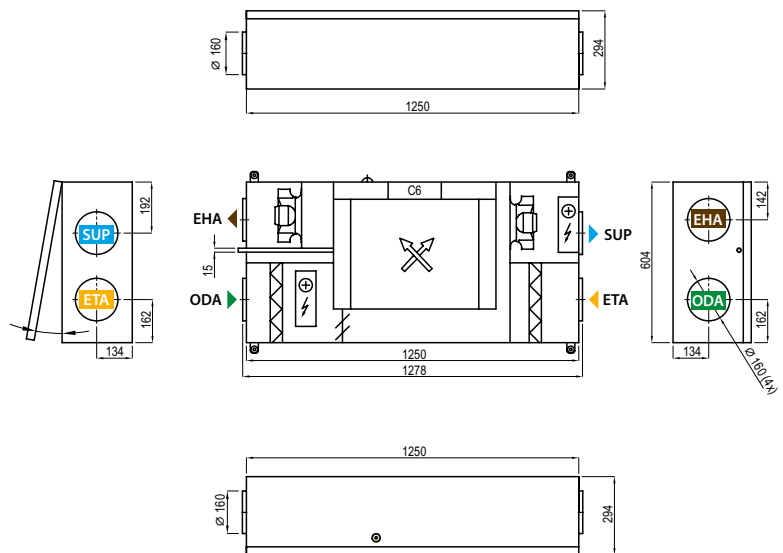

Shown as left (L1)



▶ ODA – outdoor intake ▶ SUP – supply air ▶ ETA – extract indoor ▶ EHA – exhaust air

Domekt CF 300 V C6M

Maximal air flow, m ³ /h	304
Maximal air flow, l/s	84
Reference flow rate, m ³ /s	0,059
Reference pressure difference, Pa	50
SPI, W/(m ³ /h)	0,28
Thermal efficiency of heat recovery, %	88
Electric air heater capacity, kW / Δt, °C	0,5/6,9
Electric preheater capacity, kW / Δt, °C	1/13,7
Supply voltage, V	1~230
Maximal operating current HE, A	8,3
Power supply cable, mm ²	3×1,5
Electric power input of the fan drive at maximum flow rate, W	91
Electric power input of the fan drive at reference flow rate, W	35
Noise power level, L _{WA} , dB(A)	45
Noise pressure level, L _{PA} , dB(A), (3 m)	33
Filters dimensions B×H×L, mm	365×132×46
Unit dimensions B×H×L, mm	630×790×595
Maintenance space, mm	600
Unit weight, kg	42



Performance

Unit with standard equipment

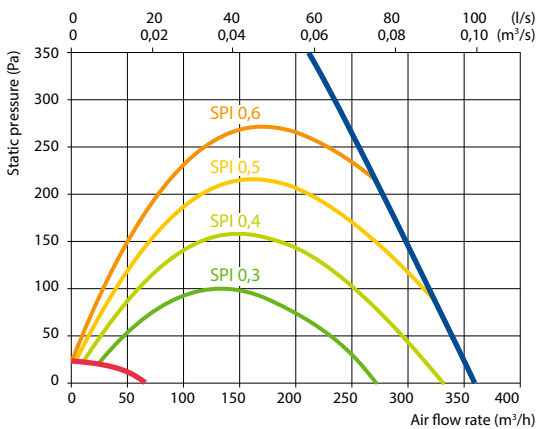

Accessories

Closing damper	AGUJ-M-160+LF230/CM230	
Silencer	ODA/EHA	AGS-160-50-600-M
	SUP/ETA	AGS-160-50-900-M
Water heater	DH-160	
PPU	PPU-HW-3R-15-0,4-W2	
2-way valve (heater)	VVP47.10-0,4+SSF161.05HF	
Water cooler	-	
2-way valve (cooler)	VVP47.10-1,6+SSF161.05HF	
Outdoor grill	LD-160	
Water heater-cooler	DHCW-160	
DX cooler	DCF-0,4-3	
Cooling unit	MOU-12HFN8a+KA8140	

Temperature efficiency

	Winter					Summer		
Outdoor temperature, °C	-23	-15	-10	-5	0	25	30	35
After heat exchanger*, °C	18,7*	19,3*	19,4*	19,4*	19,4	22,3	22,9	23,5

indoor +22 °C, 20 % RH

* calculations made after evaluation of the preheater.

Shown as right (R1)

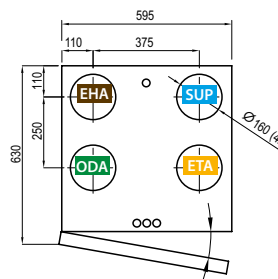
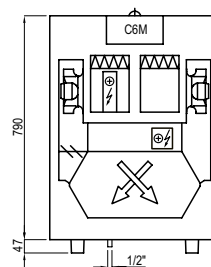

Shown as left (L1)

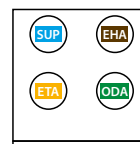

▶ ODA – outdoor intake ▶ SUP – supply air ▶ ETA – extract indoor ▶ EHA – exhaust air

Domekt CF 400 V C6M

Maximal air flow, m ³ /h	422
Maximal air flow, l/s	117
Reference flow rate, m ³ /s	0,082
Reference pressure difference, Pa	50
SPI, W/(m ³ /h)	0,29
Thermal efficiency of heat recovery, %	88
Electric air heater capacity, kW / Δt, °C	0,5/4,9
Electric preheater capacity, kW / Δt, °C	1/9,9
Supply voltage, V	1~230
Maximal operating current HE, A	8,1
Power supply cable, mm ²	3×1,5
Electric power input of the fan drive at maximum flow rate, W	120
Electric power input of the fan drive at reference flow rate, W	48
Noise power level, L _{WA} , dB(A)	45
Noise pressure level, L _{PA} , dB(A), (3 m)	34
Filters dimensions B×H×L, mm	350×220×46
Unit dimensions B×H×L, mm	585×750×598
Maintenance space, mm	750
Unit weight, kg	55



Performance

Unit with standard equipment

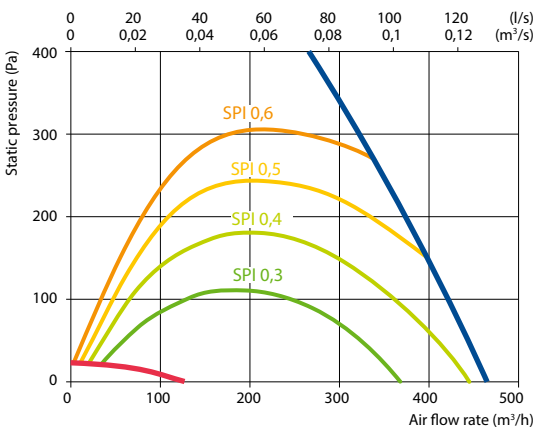

Accessories

Closing damper	AGUJ-M-160+LF230/CM230
Silencer	ODA/EHA AGS-160-50-600-M
	SUP/ETA AGS-160-50-900-M
Water heater	DH-160
PPU	PPU-HW-3R-15-0,4-W2
2-way valve (heater)	VVP47.10-0,4+SSF161.05HF
Water cooler	DCW-0,4-3
2-way valve (cooler)	VVP47.10-1,6+SSF161.05HF
Outdoor grill	LD-160
Water heater-cooler	DHCW-160
DX cooler	DCF-0,4-3
Cooling unit	MOU-12HFN8a+KA8140

Temperature efficiency

	Winter					Summer		
Outdoor temperature, °C	-23	-15	-10	-5	0	25	30	35
After heat exchanger*, °C	18,2*	18,8*	19,4*	19,4*	19,4	22,4	22,9	23,5

indoor +22 °C, 20 % RH

* calculations made after evaluation of the preheater.

Shown as right (R1)

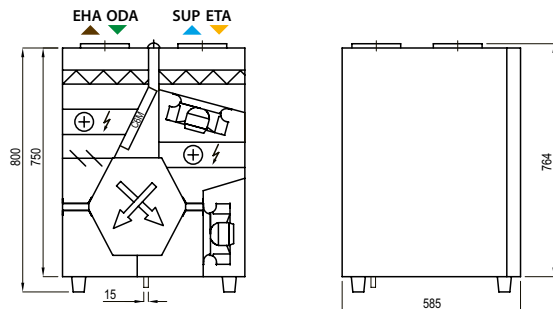

Shown as left (L1)

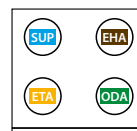

▶ ODA – outdoor intake ▶ SUP – supply air ▶ ETA – extract indoor ▶ EHA – exhaust air

Domekt CF 500 F C6M

Maximal air flow, m ³ /h	650
Maximal air flow, l/s	181
Reference flow rate, m ³ /s	0,13
Reference pressure difference, Pa	50
SPI, W/(m ³ /h)	0,22
Thermal efficiency of heat recovery, %	89
Electric air heater capacity, kW / Δt, °C	0,5/3,1
Electric preheater capacity, kW / Δt, °C	1/6,2
Supply voltage, V	1~230
Maximal operating current HE, A	10
Power supply cable, mm ²	3×1,5
Electric power input of the fan drive at maximum flow rate, W	167
Electric power input of the fan drive at reference flow rate, W	56
Noise power level, L _{WA} , dB(A)	45
Noise pressure level, L _{PA} , dB(A), (3 m)	33
Filters dimensions B×H×L, mm	473×242×46
Unit dimensions B×H×L, mm	1045×292×1400
Maintenance space, mm	560
Unit weight, kg	93



Performance

Unit with standard equipment

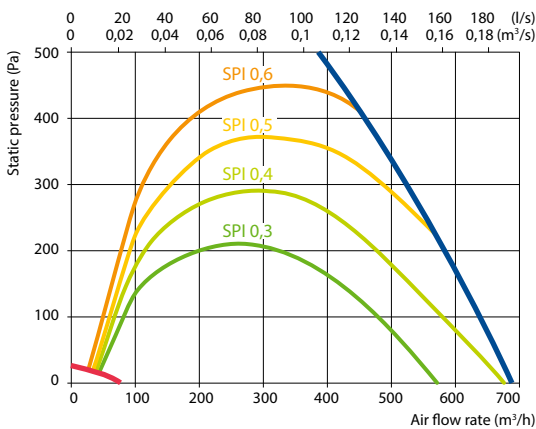

Accessories

Closing damper	AGUJ-M-200+LF230/CM230
Silencer	ODA/EHA AGS-200-50-600-M
	SUP/ETA AGS-200-50-900-M
Water heater	DH-200
PPU	PPU-HW-3R-15-0,4-W2
2-way valve (heater)	VVP47.10-0,4+SSF161.05HF
Water cooler	DCW-0,5-3
2-way valve (cooler)	VVP47.10-1,6+SSF161.05HF
Outdoor grill	LD-200
Water heater-cooler	DHCW-200
DX cooler	DCF-0,5-3
Cooling unit	MOU-12HFN8a+KA8140

Mounting positions



Temperature efficiency

	Winter					Summer		
Outdoor temperature, °C	-23	-15	-10	-5	0	25	30	35
After heat exchanger*, °C	17,4*	18,2*	18,9*	18,9*	18,9	22,4	23,1	23,8

indoor +22 °C, 20 % RH

* calculations made after evaluation of the preheater.

Shown as right (R1)

View from inspection side

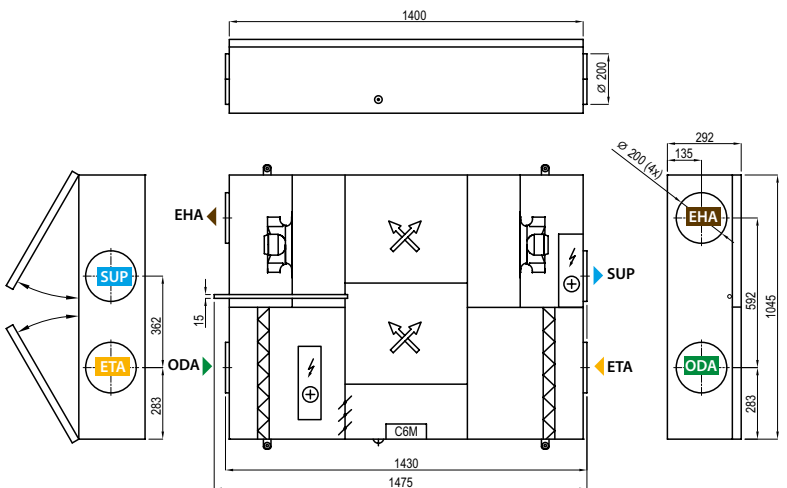

Shown as left (L1)



▶ ODA – outdoor intake ▶ SUP – supply air ▶ ETA – extract indoor ▶ EHA – exhaust air

Domekt CF 700 V C6M

Maximal air flow, m ³ /h	650
Maximal air flow, l/s	181
Reference flow rate, m ³ /s	0,130
Reference pressure difference, Pa	50
SPI, W/(m ³ /h)	0,26
Thermal efficiency of heat recovery, %	89
Electric air heater capacity, kW / Δt, °C	1/6,2
Electric preheater capacity, kW / Δt, °C	1/6,2
Supply voltage, V	1~230
Maximal operating current HE, A	11,6
Power supply cable, mm ²	3×1,5
Electric power input of the fan drive at maximum flow rate, W	178
Electric power input of the fan drive at reference flow rate, W	73
Noise power level, L _{WA} , dB(A)	46
Noise pressure level, L _{PA} , dB(A), (3 m)	35
Filters dimensions B×H×L, mm	390×300×46
Unit dimensions B×H×L, mm	491×1220×1020
Maintenance space, mm	1020
Unit weight, kg	100



Performance

Unit with standard equipment

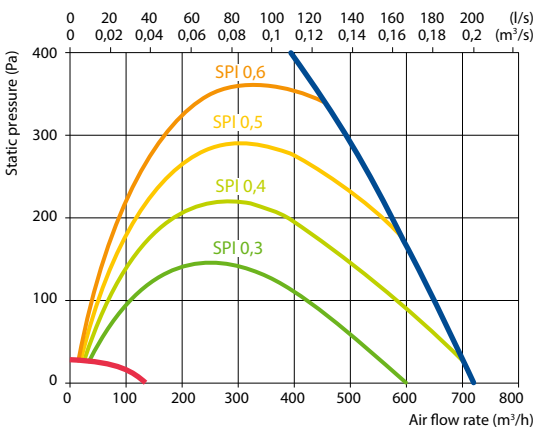

Accessories

Closing damper	AGUJ-M-200+LF230/CM230
Silencer	ODA/EHA AGS-200-50-600-M
	SUP/ETA AGS-200-50-900-M
Water heater	DH-200
PPU	PPU-HW-3R-15-0,4-W2
2-way valve (heater)	VVP47.10-0,4+SSF161.05HF
Water cooler	DCW-0,7-5
2-way valve (cooler)	VVP47.15-2,5+SSF161.05HF
Outdoor grill	LD-200
Water heater-cooler	DHCW-200
DX cooler	DCF-0,7-5
Cooling unit	MOU-18HFN8a+KA8140

Temperature efficiency

	Winter				Summer			
Outdoor temperature, °C	-23	-15	-10	-5	0	25	30	35
After heat exchanger*, °C	17,3*	17,9*	18,5*	19*	19	22,4	23,1	23,7

indoor +22 °C, 20 % RH

* calculations made after evaluation of the preheater.

Shown as right (R1)

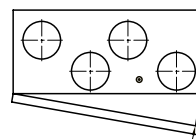
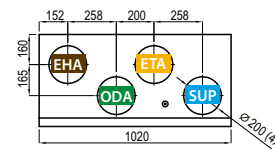
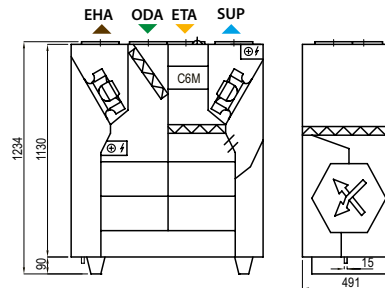

Shown as left (L1)

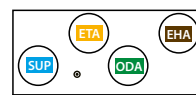

▶ ODA – outdoor intake ▶ SUP – supply air ▶ ETA – extract indoor ▶ EHA – exhaust air

Domekt CF 700 H C6M

Maximal air flow, m ³ /h	621
Maximal air flow, l/s	173
Reference flow rate, m ³ /s	0,121
Reference pressure difference, Pa	50
SPI, W/(m ³ /h)	0,25
Thermal efficiency of heat recovery, %	89
Electric air heater capacity, kW / Δt, °C	0,5/3,4
Electric preheater capacity, kW / Δt, °C	1,5/10,1
Supply voltage, V	1~230
Maximal operating current HE, A	11,6
Power supply cable, mm ²	3×1,5
Electric power input of the fan drive at maximum flow rate, W	180
Electric power input of the fan drive at reference flow rate, W	71
Noise power level, L _{WA} , dB(A)	46
Noise pressure level, L _{PA} , dB(A), (3 m)	34
Filters dimensions B×H×L, mm	390×300×46
Unit dimensions B×H×L, mm	487×700×1500
Maintenance space, mm	500
Unit weight, kg	95



Performance

Unit with standard equipment

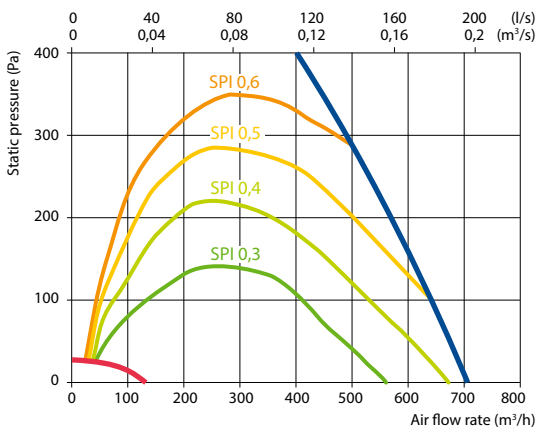

Accessories

Closing damper	AGUJ-M-250+LF230/CM230
Silencer	ODA/EHA AGS-250-50-600-M
	SUP/ETA AGS-250-50-900-M
Water heater	DH-250
PPU	PPU-HW-3R-15-0,63-W2
2-way valve (heater)	VVP47.10-0,63+SSF161.05HF
Water cooler	DCW-0,7-5
2-way valve (cooler)	VVP47.15-2,5+SSF161.05HF
Outdoor grill	LD-250
Water heater-cooler	DHCW-250
DX cooler	DCF-0,7-5
Cooling unit	MOU-18HFN8a+KA8140

Temperature efficiency

	Winter				Summer			
Outdoor temperature, °C	-23	-15	-10	-5	0	25	30	35
After heat exchanger*, °C	17,7*	18,3*	19*	19*	19	22,4	23,1	23,8

indoor +22 °C, 20 % RH

* calculations made after evaluation of the preheater.

Shown as right (R1)

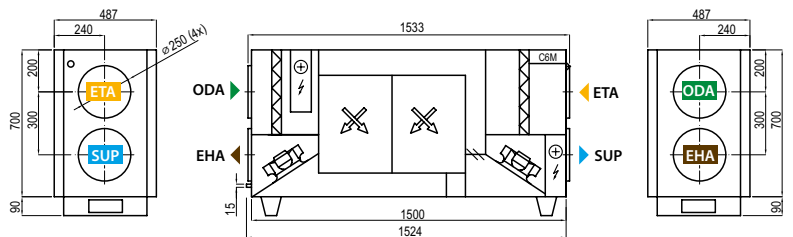

Shown as left (L1)

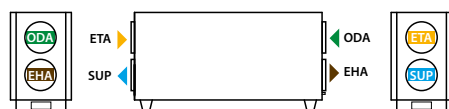

▶ ODA – outdoor intake ▶ SUP – supply air ▶ ETA – extract indoor ▶ EHA – exhaust air

Domekt CF 700 F C6M

Maximal air flow, m ³ /h	706
Maximal air flow, l/s	196
Reference flow rate, m ³ /s	0,14
Reference pressure difference, Pa	50
SPI, W/(m ³ /h)	0,23
Thermal efficiency of heat recovery, %	88
Electric air heater capacity, kW / Δt, °C	1/5,8
Electric preheater capacity, kW / Δt, °C	1/5,8
Supply voltage, V	1~230
Maximal operating current HE, A	11,6
Power supply cable, mm ²	3×1,5
Electric power input of the fan drive at maximum flow rate, W	176
Electric power input of the fan drive at reference flow rate, W	67
Noise power level, L _{WA} , dB(A)	45
Noise pressure level, L _{PM} , dB(A), (3 m)	34
Filters dimensions B×H×L, mm	390×287×46
Unit dimensions B×H×L, mm	875×344×1365
Maintenance space, mm	300
Unit weight, kg	84

NEW

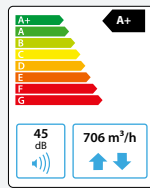

Performance

Unit with standard equipment

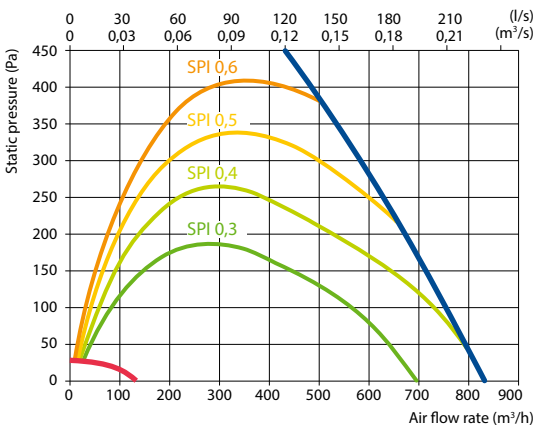

Accessories

Closing damper	AGUJ-M-250+LF230/CM230
Silencer	ODA/EHA AGS-250-50-600-M
	SUP/ETA AGS-250-50-900-M
Water heater	DH-250
PPU	PPU-HW-3R-15-0,63-W2
2-way valve (heater)	VVP47.10-0,63+SSF161.05HF
Water cooler	DCW-0,7-5
2-way valve (cooler)	VVP47.15-2,5+SSF161.05HF
Outdoor grill	LD-250
Water heater-cooler	DHCW-250
DX cooler	DCF-0,7-5
Cooling unit	MOU-18HFN8a+KA8140

Mounting positions



Temperature efficiency

Outdoor temperature, °C	Winter					Summer		
	-23	-15	-10	-5	0	25	30	35
After heat exchanger*, °C	17*	17,7*	18,5*	18,6*	18,6	22,5	23,2	23,9

indoor +22 °C, 20 % RH

* calculations made after evaluation of the preheater.

Shown as right (R1)

View from inspection side

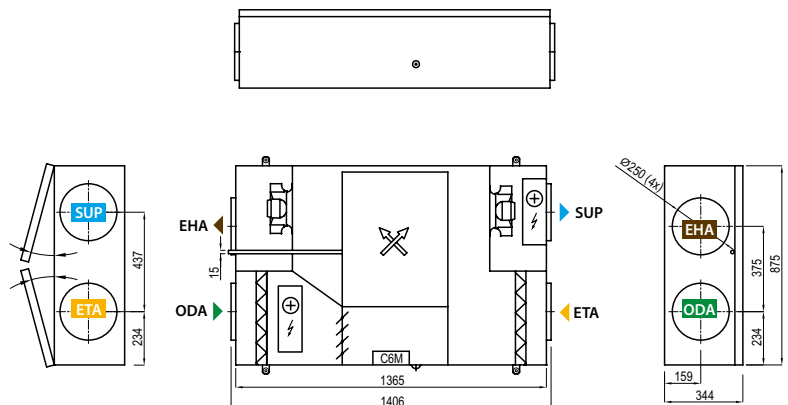

Shown as left (L1)



▶ ODA – outdoor intake ▶ SUP – supply air ▶ ETA – extract indoor ▶ EHA – exhaust air

Domekt S

False ceiling supply air handling units

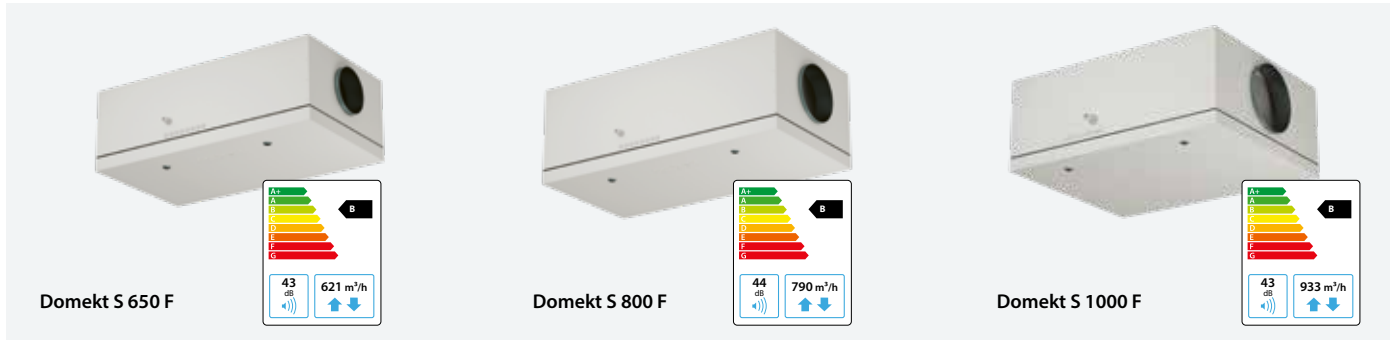

Sizes and air volumes of Domekt S units

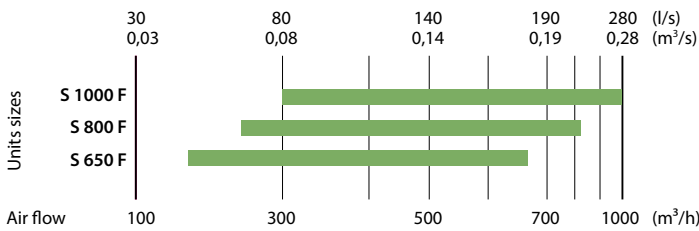

Mounting positions

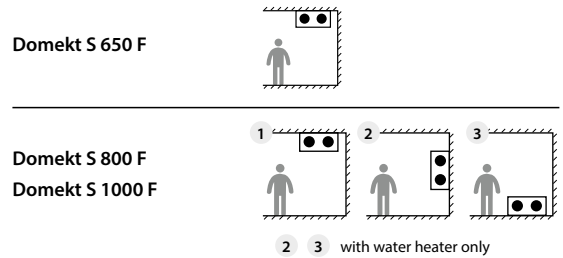

Modifications of Domekt S units

Unit	Supply air filter class		Heater		Cooler		Control system
	ePM1 60 %	ePM10 50 %	HE	HW	HCW	HCDX	C5
Domekt S 650 F	○	●	●		△	△	●
Domekt S 800 F	○	●	●	○	△	△	●
Domekt S 1000 F	○	●	●	○	△	△	●



● standard equipment ○ possible choice △ ordered separately duct heater/cooler The markings are explained on p. 7.

Technical data

Domekt S unit	Domekt S 650 F	Domekt S 800 F	Domekt S 1000 F
Maximum air flow, m³/h	621	790	933
Electric power input of the fan drive at reference flow rate, W	64	75	83
Sound pressure level L_{pA} , dB(A), distance from casing – 3 m	43	44	43
Filters dimensions BxHxL, mm	371x235x46	371x287x46	558x287x46
Unit weight, kg	35	37	46

Unit / dimension (mm)	L	L1	H	H1	B	B1	D
Domekt S 650 F	873	919	297	120	475	237,5	∅ 160
Domekt S 800 F	973	1005	350	152	475	237,5	∅ 200
Domekt S 1000 F	893	925	350	152	700	350	∅ 250

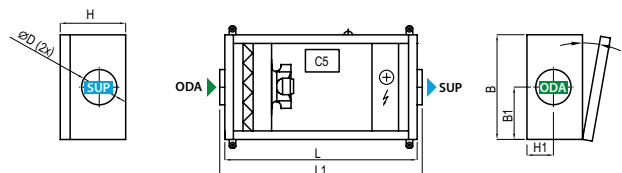

Detailed technical characteristics of the units can be obtained with the DOMEKT selection software

▶ ODA – outdoor intake ▶ SUP – supply air ▶ ETA – extract indoor ▶ EHA – exhaust air



VERSO

Efficient and Advanced
Commercial Ventilation

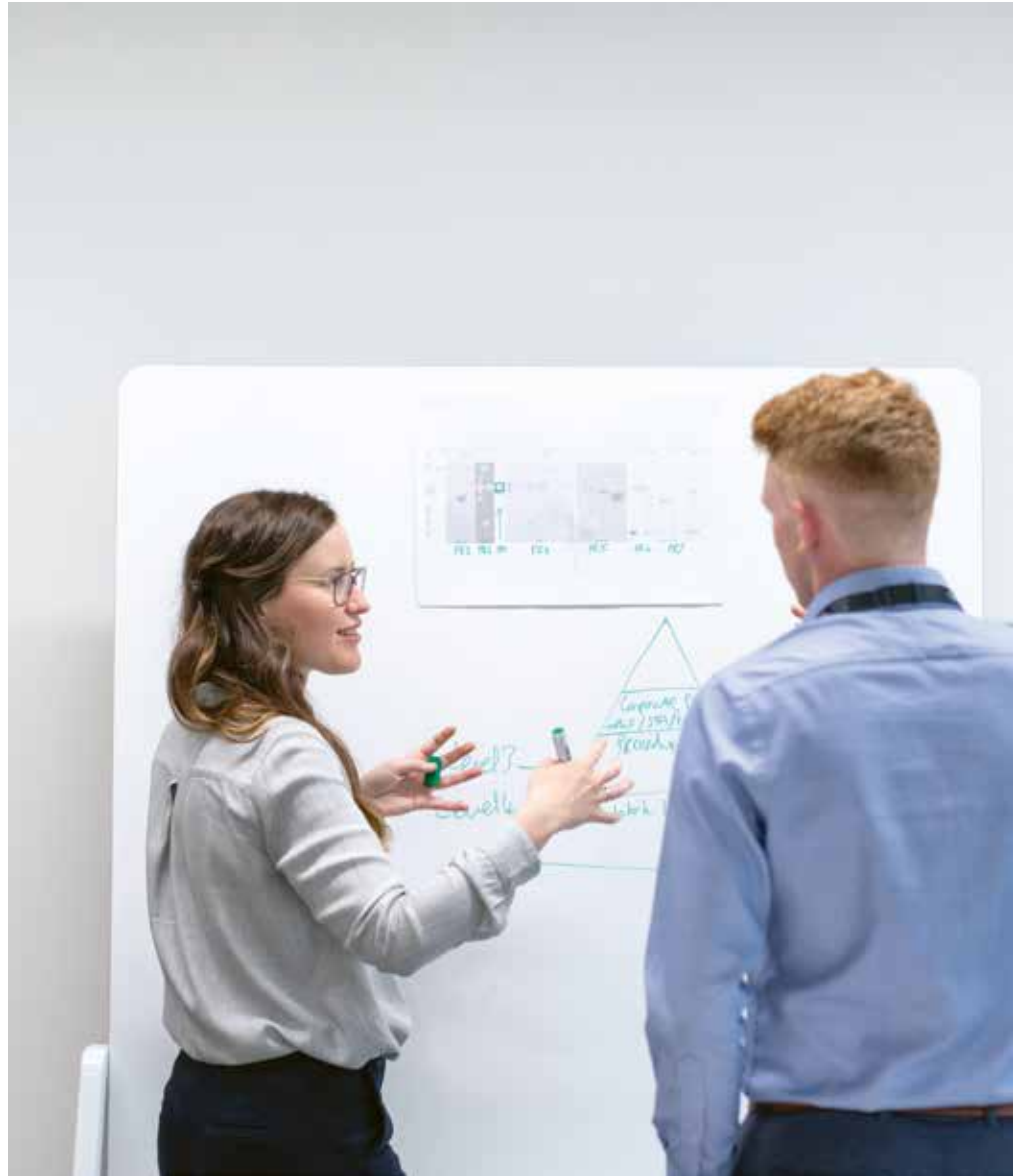

The widest product range, designed for ventilation of various commercial premises and offering standardized or individual project solutions

VERSO Standard features



COMPACT UNITS FOR CONVENIENT TRANSPORTATION

- Most of the units can be moved through a standard, 900 mm wide door opening.
- Larger units can be split into separate sections.
- We offer mounting frames for all units (except flat ones), which ensures easier transportation.



WIDE RANGE OF FLAT UNITS

7 different models of low-profile F units for saving space when mounted on the ceiling. Some of the units have optional sliding doors, for easier access when installed above false ceiling constructions. Flat units with rotary heat exchangers as well as supply units can also be mounted on the wall or on the floor if needed*.

* AHU's with water heater only.



SORPTION-ENTHALPY ROTARY HEAT EXCHANGER

- Sorption-enthalpy rotary heat exchanger controls the humidity in the premises more efficiently than a condensing rotor. Now sorption-enthalpy is an available option for all Verso R Standard units (except Verso R 2000/3000 F C5 models).
- The humidity from the exhaust air is used to humidify the supply air in winter.
- Wet supplied air in the summertime is dried.
- High comfort is ensured all year long.

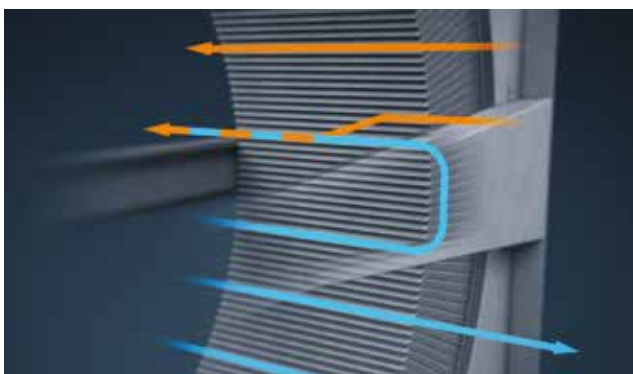

PURGE SECTOR TO PREVENT AIR MIXING

The purge sector is a solution for units with rotary heat exchangers, allowing to minimize air mixing between the air flows almost to zero. A small part of the supply air flow is directed through the purge sector, thus preventing extracted air to return into the premises.



INTEGRATED DX COIL

- All VERSO Standard units of the universal type can be ordered with an integrated DX coil.
- Extremely economical air heating even at very low outdoor temperatures.
- Cooling/heating power control.
- Wide range of inverter outdoor units.



MULTI-LEVEL FROST PREVENTION OPTION

- Reduces the energy consumption used for counterflow heat exchanger defrost.
- Less power of the post-heater is needed to reach desired temperatures in winter conditions.
- For water heaters, smaller size PPU can be used.
- Better seasonal heat recovery efficiency is achieved.

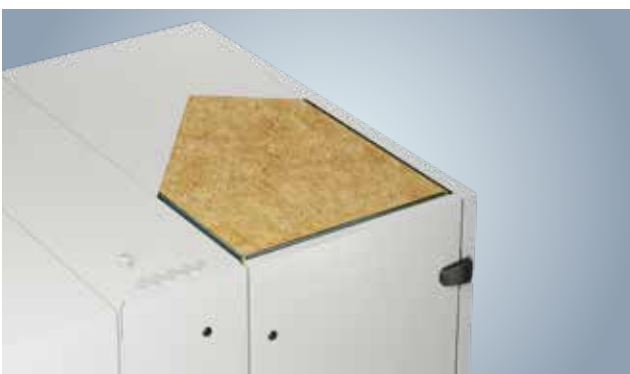

EUROVENT CERTIFICATED CASING T2 / TB2 / D1 / L1

- The casing is filled with 50 mm long-lasting, fire-resistant mineral wool.
- Reduced thermal bridges ensure minimal heat loss through the case and the possibility of condensation both inside and outside the unit.
- The casing filled with mineral wool perfectly reduces noise in the environment.

EUROVENT CERTIFIED

VERSO units are tested on a regular basis at the Eurovent climatic laboratory in Germany. Parameters such as performance, efficiency, noise level, tolerances and other are tested.



VERSO U UNITS

Duct connections can be relocated from the sides of the unit to the top and vice versa. Each universal unit has 16 different duct layout options that are easy to change during installation, depending on the intended installation location.

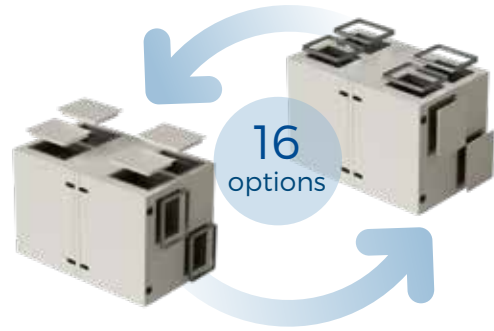

DUCTS CONNECTION OPTIONS OF UNIVERSAL UNITS

Apply to these models: Verso R 1000-4000 U C5, Verso CF 1000-3500 U C5.

Right inspection side

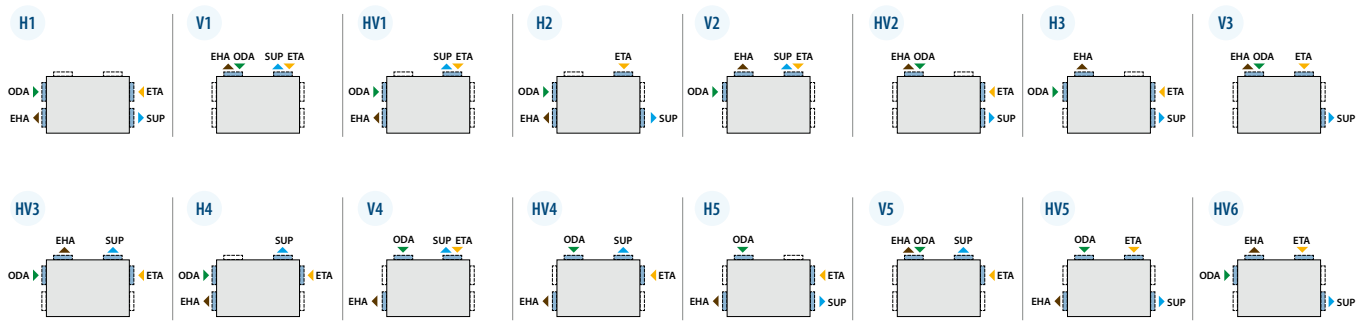

Left inspection side

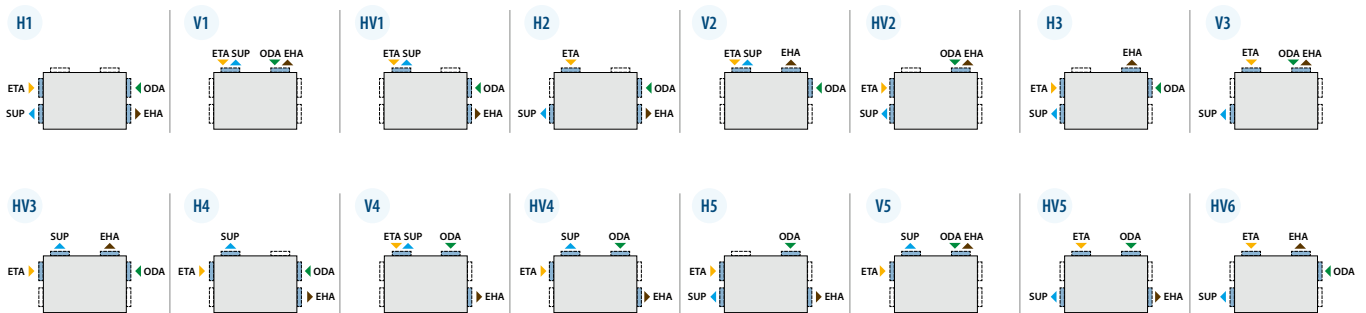

▶ ODA – outdoor intake ▶ SUP – supply air ▶ ETA – extract indoor ▶ EHA – exhaust air

Verso Standard range review



Verso R Standard with rotary heat exchanger

A wide selection of compact units with non-freezing rotary heat exchanger, horizontal, vertical, universal and flat installation. Verso R Standard units efficiently save energy all year round by significantly reducing both heating and air conditioning costs. Ideal for cold weather countries. Sorption-enthalpy rotary heat exchangers maintain comfortable indoor climate in the premises.



Verso CF Standard with counterflow heat exchanger

A wide selection of compact units with counterflow plate heat exchanger, horizontal, vertical, universal and flat installation. Verso CF Standard units efficiently save energy all year round by significantly reducing both heating and air conditioning costs. Ideal for mild and warm climate countries.



Verso S Standard supply air handling unit

Low-height false ceiling supply air handling units are easily installed even in the smallest premises. All Verso S Standard units have integrated control system, which simplifies units' installation.



Verso R Standard

Air handling units with rotary heat exchanger

Sizes and capacities of Verso R Standard units

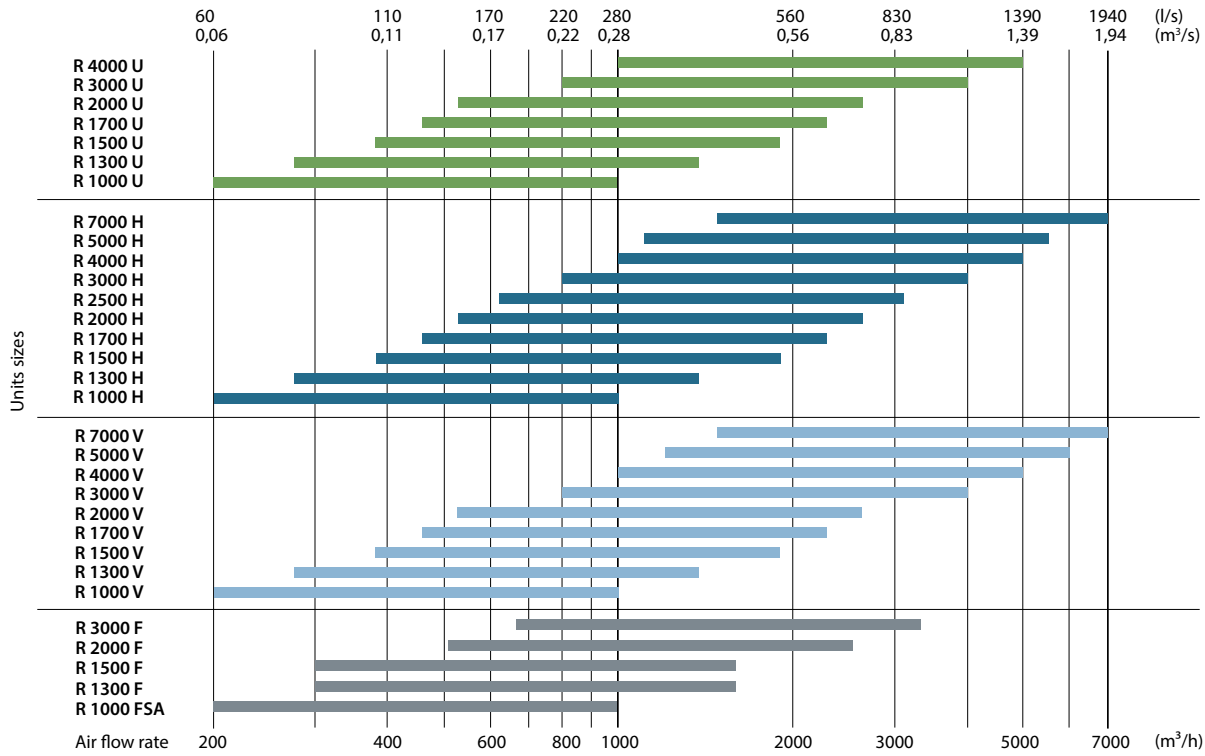

Modifications of Verso R Standard units

Unit	Heat exchanger			Supply/exhaust air filter class ePM1 60% / ePM10 50%	Heater			Cooler		Inspection side				Control system C5
	Condensing L/A	SL/A	Enthalpy L/AZ		HE	HW	HCW	DCW	HCDX	R1	L1	R2	L2	
Verso R 1000 U	●	○	○	●	○		○	△	○	○	○			●
Verso R 1000 H/V	●	○	○	●	○	○		△	△	○	○			●
Verso R 1000 FSA	●	○		●	●					○	○			●
Verso R 1300 U	●	○	○	●	○		○	△	○	○	○			●
Verso R 1300 H/V	●	○	○	●	○	○		△	△	○	○			●
Verso R 1300 F	●	○	○	●	●	△	△	△	△	○	○			●
Verso R 1500 U	●	○	○	●	○		○	△	△	○	○			●
Verso R 1500 H/V	●	○	○	●	○	○		△	△	○	○			●
Verso R 1500 F	●	○		●	●	△	△	△	△	○	○			●
Verso R 1700 U	●	○	○	●	○		○	△	○	○	○			●
Verso R 1700 H/V	●	○	○	●	○	○		△	△	○	○			●
Verso R 2000 U	●	○	○	●	○		○	△	○	○	○			●
Verso R 2000 H/V	●	○	○	●	○	○		△	△	○	○			●
Verso R 2000 F	●	○		●	●	△	△	△	△	○	○			●
Verso R 2500 H	●	○	○	●	○	○		△	△	○	○	○	○	●
Verso R 3000 U	●	○	○	●	○		○	△	○	○	○			●
Verso R 3000 H/V	●	○	○	●	○	○		△	△	○	○			●
Verso R 3000 F	●	○		●	●	△		△	△	○	○			●
Verso R 4000 U	●	○	○	●	○		○	△	○	○	○			●
Verso R 4000 H/V	●	○	○	●	○	○		△	△	○	○			●
Verso R 5000 V	●	○	○	●	○	○	○		○	○	○			●
Verso R 5000 H	●	○	○	●	○	●		△	△	○	○	○	○	●
Verso R 7000 V	●	○	○	●	○	○	○		○	○	○			●
Verso R 7000 H	●	○	○	●	○	●		△	△	○	○			●

● standard equipment ○ possible choice △ ordered separately duct heater/cooler The markings are explained on p. 7.

Verso R 1000 U C5

Nominal air flow according to ErP 2018, m ³ /h	979
Nominal air flow according to ErP 2018, l/s	272
Electric air heater capacity, kW / Δt, °C	3/8,9
Supply voltage HE, V	3~400
Supply voltage HW, V	1~230
Maximal operating current HE, A	7,3
Maximal operating current HW, A	3,3
Power supply cable E, mm ²	5×1,5
Power supply cable W, mm ²	3×1,5
Electric power input of the fan drive at maximum flow rate, W	180
Noise power level, L _{WA} , dB(A)	52
Noise pressure level, L _{PA} , dB(A), (3 m)	42
Filters dimensions B×H×L, mm	800×400×46
Unit dimensions B×H×L, mm	906×905×1355
Panel thickness, mm	50
Maintenance space, mm	800
Unit weight, kg	196



Performance

Verso R 1000 UH with standard equipment

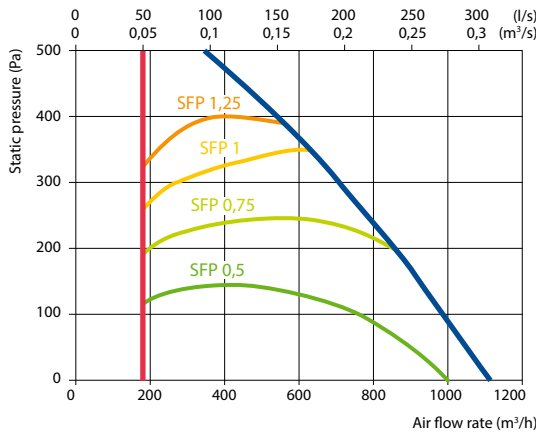

Temperature efficiency

Outside temperature, °C	Winter					Summer		
	-23	-15	-10	-5	0	25	30	35
After heat exchanger, °C	13,7	15,2	16,1	17,0	17,9	22,6	23,5	24,4

Indoor +22 °C, 20 % RH

Changeover water/ DX heating – cooling exchanger (HCW/HCDX)

	Winter		Summer	
	Water temperature in/out, °C	60/40	7/12	–
Condensation/evaporation T, °C	–	–	45	45/5
Capacity, kW	2,8	5,7	2,6	6,7
Maximal capacity, kW	7,0	7,5	6,1	9,3
Pressure drop, kPa	1	4,1	–	–
Air temperature in/out, °C	13,8 / 22	30 / 18	13,8 / 22	30 / 18
Connection, " / mm	¾		½ / 22	

Summer: +30 °C / 50 %; HCW – 899 m³/h

Accessories

Closing damper	AGUJ-M-315+LF24/LM24
Silencer	ODA/EHA AGS-315-100-900-M
	SUP/ETA AGS-315-100-1200-M
PPU	PPU-HW-3R-15-0,63-W2
Water cooler	DCW-0,9-6
2-way valve	VVP47.15-2,5+SSF161.05HF
DX cooler	DCF-0,9-6
Cooling unit	MOU 18HFN8a+KA8140

Shown as right (R1)

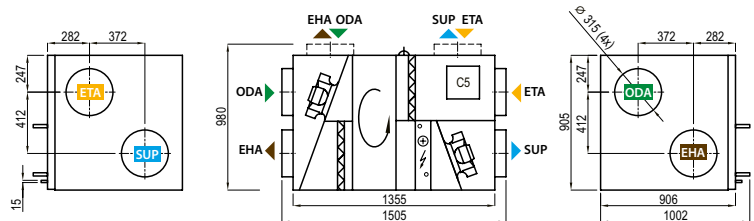

Shown as left (L1)

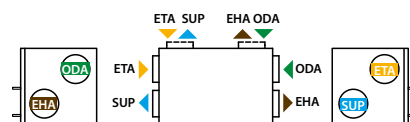

▶ ODA – outdoor intake ▶ SUP – supply air ▶ ETA – extract indoor ▶ EHA – exhaust air

DECENTRALIZED VENTILATION WITHOUT A DUCT SYSTEM **VERSO R 1000 FSA C5**



The unit is intended to easily add ventilation to renovated buildings where centralized ventilation is not an option.



- Integrated silencers.
- Integrated air supply and exhaust grille.
- Motorized supply and exhaust dampers.
- CO₂, humidity and temperature sensors (optional).
- Control panel.
- Suitable for educational and training facilities, meeting rooms, offices and public buildings where silent operation is a key demand.

Verso R 1000 FSA C5

Nominal air flow according to ErP 2018, m ³ /h	1000
Nominal air flow according to ErP 2018, l/s	278
Electric air heater capacity, kW / Δt, °C	3/8,8
Supply voltage HE, V	3~400
Maximal operating current HE, A	11,1
Power supply cable E, mm ²	5x1,5
Electric power input of the fan drive at maximum flow rate, W	123
Noise power level, L _{WA} , dB(A)	42
Noise pressure level, L _{PA} , dB(A), (3 m)	31
Filters dimensions BxHxL, mm	472x402x96
Unit dimensions BxHxL, mm	1050x485x3000
Panel thickness, mm	50
Maintenance space, mm	660
Unit weight, kg	238



Performance

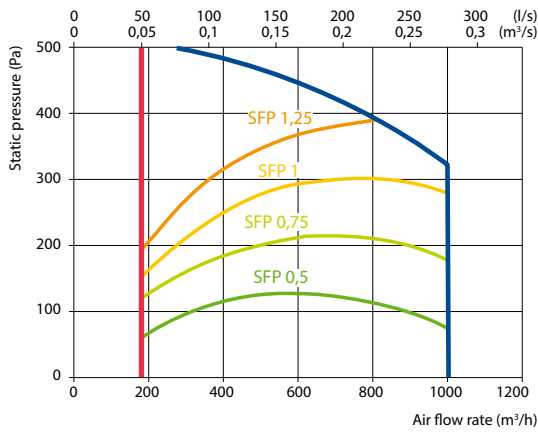

Accessories

Closing damper	AGUJ-M-315+LM24
Outdoor grill	LD-318

Mounting positions

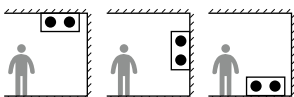

Temperature efficiency

Outside temperature, °C	Winter					Summer		
	-23	-15	-10	-5	0	25	30	35
After heat exchanger, °C	11,8	13,6	14,7	15,9	17,0	22,7	23,8	25,0

Indoor +22 °C, 20 % RH

Shown as right (R1)

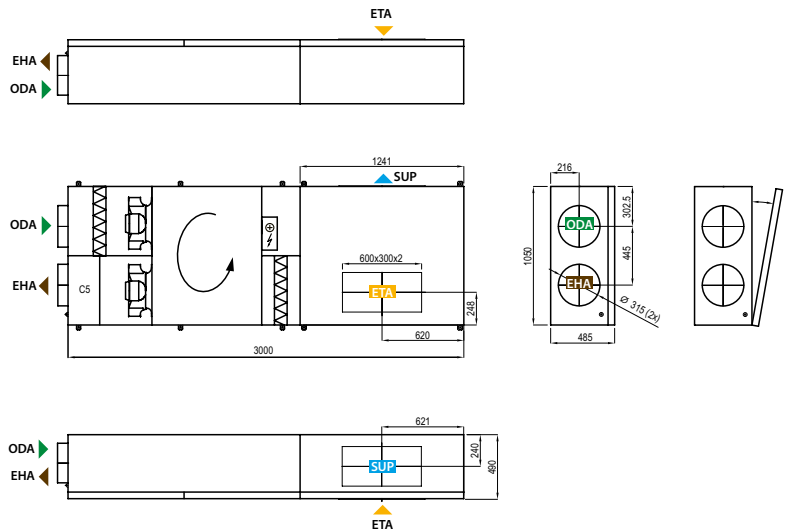

Shown as left (L1)

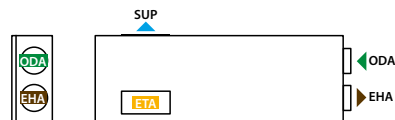

▶ ODA – outdoor intake ▶ SUP – supply air ▶ ETA – extract indoor ▶ EHA – exhaust air

Verso R 1300 U C5

Nominal air flow according to ErP 2018, m ³ /h	1468
Nominal air flow according to ErP 2018, l/s	408
Electric air heater capacity, kW / Δt, °C	4,5/9
Supply voltage HE, V	3~400
Supply voltage HW, V	1~230
Maximal operating current HE, A	12,7
Maximal operating current HW, A	6,5
Power supply cable E, mm ²	5×1,5
Power supply cable W, mm ²	3×1,5
Electric power input of the fan drive at maximum flow rate, W	270
Noise power level, L _{WA} , dB(A)	58
Noise pressure level, L _{PM} , dB(A), (3 m)	48
Filters dimensions B×H×L, mm	800×400×46
Unit dimensions B×H×L, mm	906×905×1355
Panel thickness, mm	50
Maintenance space, mm	800
Unit weight, kg	203



Performance

Verso R 1300 UH with standard equipment

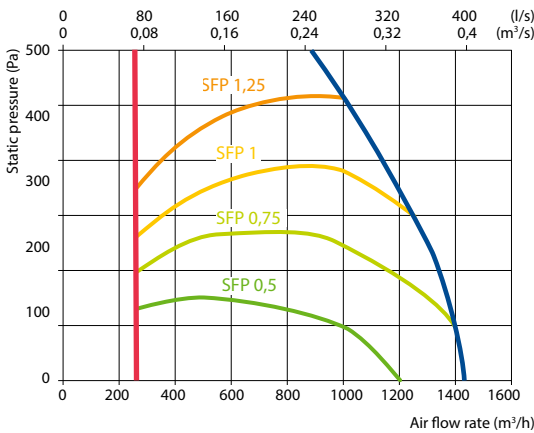

Temperature efficiency

	Winter					Summer		
Outside temperature, °C	-23	-15	-10	-5	0	25	30	35
After heat exchanger, °C	12,7	14,3	15,4	16,4	17,4	22,6	23,7	24,7

Indoor +22 °C, 20 % RH

Changeover water/ DX heating – cooling exchanger (HCW/HCDX)

	Winter	Summer	Winter	Summer
Water temperature in/out, °C	60/40	7/12	–	–
Condensation/evaporation T, °C	–	–	45	45/5
Capacity, kW	4,2	7,9	9,2	4,2
Maximal capacity, kW	10,2	9,3	10,8	7,9
Pressure drop, kPa	1	7,6	–	–
Air temperature in/out, °C	12,7 / 22	30 / 18	12,7 / 22	30 / 18
Connection, " / mm	¾		½ / 22	

Summer: +30 °C / 50 %; HCW – 1350 m³/h

Accessories

Closing damper	AGUJ-M-315+LF24/LM24
Silencer	ODA/EHA AGS-315-100-900-M
	SUP/ETA AGS-315-100-1200-M
PPU	PPU-HW-3R-15-1-W2
Water cooler	DCW-1,2-8
2-way valve	VVP47.20-4.0+SSF161.05HF
DX cooler	DCF-1,2-8
Cooling unit	MOU 36HFN8a+KA8140

Shown as right (R1)

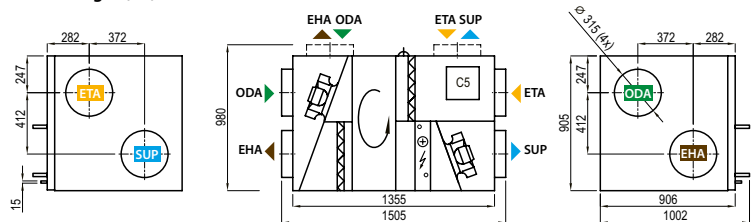

Shown as left (L1)

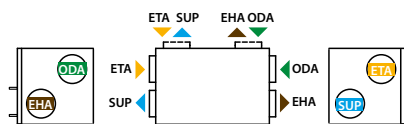

▶ ODA – outdoor intake ▶ SUP – supply air ▶ ETA – extract indoor ▶ EHA – exhaust air

Verso R 1300 F C5

Nominal air flow according to ErP 2018, m ³ /h	1134
Nominal air flow according to ErP 2018, l/s	315
Electric air heater capacity, kW / Δt, °C	3/5,7
Supply voltage HE, V	3~400
Supply voltage HW, V	1~230
Maximal operating current HE, A	11,1
Maximal operating current HW, A	7,1
Power supply cable E, mm ²	5×1,5
Power supply cable W, mm ²	3×1,5
Electric power input of the fan drive at maximum flow rate, W	370
Noise power level, L _{WA} , dB(A)	54
Noise pressure level, L _{PA} , dB(A), (3 m)	44
Filters dimensions B×H×L, mm	410×420×46
Unit dimensions B×H×L, mm	940×480×1360
Panel thickness, mm	50
Maintenance space, mm	400
Unit weight, kg	144



Performance

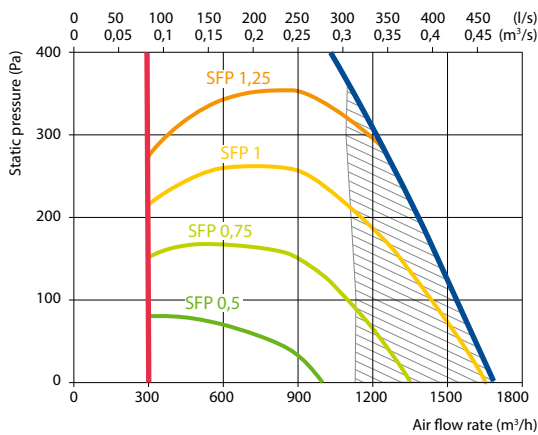

Does not conform to ErP2018 requirements

Accessories

Closing damper	AGUJ-M-315+LF24/LM24
Silencer	ODA/EHA AGS-315-100-900-M
	SUP/ETA AGS-315-100-1200-M
Water heater	DH-315
PPU	PPU-HW-3R-15-1,0-W2
Water cooler	DCW-1,2-8
Water heater-cooler	DHCW-315
2-way valve	VVP47.15-2,5+SSF161.05HF
DX cooler	DCF-1,2-8
Cooling unit	MOU 24HFN8a+KA8140

Mounting positions

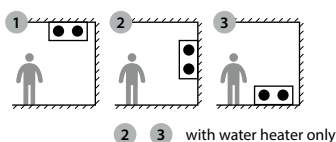

Temperature efficiency

Outside temperature, °C	Winter					Summer		
	-23	-15	-10	-5	0	25	30	35
After heat exchanger, °C	10,0	12,1	13,5	14,8	16,1	22,8	24,1	25,5

Indoor +22 °C, 20 % RH

Hot water duct air heater *

Water temperature in/out, °C	Winter		
	80/60	70/50	60/40
Capacity, kW	4,8	4,8	4,8
Flow rate, dm ³ /h	214	213	212
Pressure drop, kPa	10,9	11,0	11,0
Temperature in/out, °C	10,0 / 22,0		
Maximal capacity, kW	12,4	10,2	8,0
Connection, "	½		

* Option

Shown as right (R1)
View from inspection side

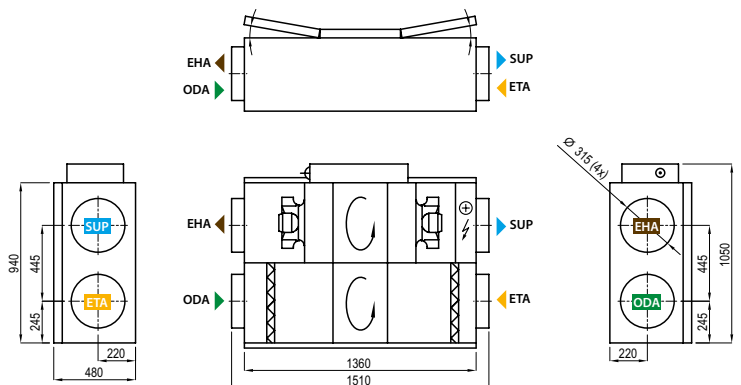

Shown as left (L1)

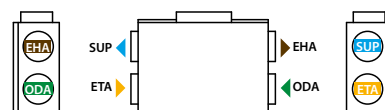

▶ ODA – outdoor intake ▶ SUP – supply air ▶ ETA – extract indoor ▶ EHA – exhaust air

Verso R 1500 U C5

Nominal air flow according to ErP 2018, m ³ /h	1634
Nominal air flow according to ErP 2018, l/s	454
Electric air heater capacity, kW / Δt, °C	4,5/7
Supply voltage HE, V	3~400
Supply voltage HW, V	1~230
Maximal operating current HE, A	13,3
Maximal operating current HW, A	7,1
Power supply cable E, mm ²	5×2,5
Power supply cable W, mm ²	3×1,5
Electric power input of the fan drive at maximum flow rate, W	450
Noise power level, L _{WA} , dB(A)	54
Noise pressure level, L _{pA} , dB(A), (3 m)	44
Filters dimensions B×H×L, mm	800×400×46
Unit dimensions B×H×L, mm	906×905×1355
Panel thickness, mm	50
Maintenance space, mm	800
Unit weight, kg	206



Performance

Verso R 1500 UH with standard equipment

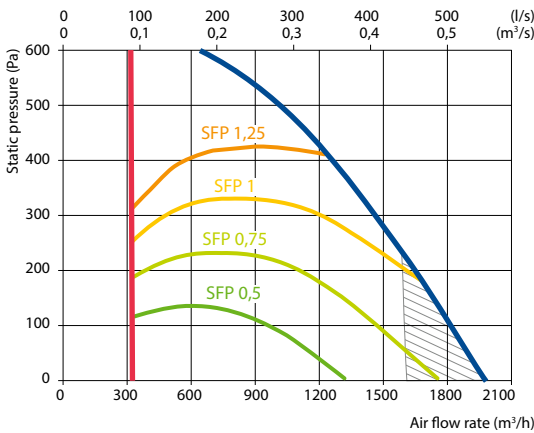

Does not conform to ErP2018 requirements

Accessories

Closing damper	AGUJ-M-315+LF24/LM24
Silencer	ODA/EHA AGS-315-100-900-M
	SUP/ETA AGS-315-100-1200-M
PPU	PPU-HW-3R-15-1,6-W2
Water cooler	DCW-1,4-9
2-way valve	VVP47.20-4,0+SSF161.05HF
DX cooler	DCF-1,4-10
Cooling unit	MOU 36HFN8a+KA8140

Temperature efficiency

	Winter					Summer		
Outside temperature, °C	-23	-15	-10	-5	0	25	30	35
After heat exchanger, °C	12,3	14,0	15,1	16,2	17,2	22,6	23,7	24,8
Indoor +22 °C, 20 % RH								

Changeover water/ DX heating – cooling exchanger (HCW/HCDX)

	Winter	Summer	Winter	Summer
Water temperature in/out, °C	60/40	7/12	–	–
Condensation/evaporation T, °C	–	–	45	45/5
Capacity, kW	5,2	9,5	5,2	10,8
Maximal capacity, kW	11,7	10,3	9	11,6
Pressure drop, kPa	1	10,8	–	–
Air temperature in/out, °C	12,3 / 22	30 / 18	12,3 / 22	30 / 18
Connection, " / mm	¾		½ / 22	

Summer: +30 °C / 50 %; HCW – 1500 m³/h

Shown as right (R1)

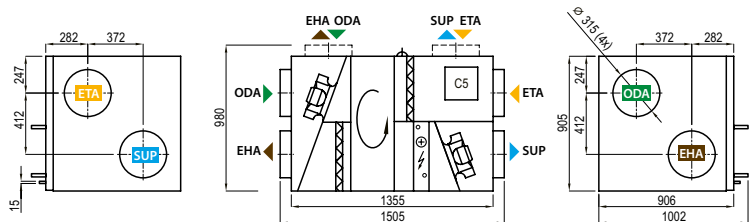

Shown as left (L1)

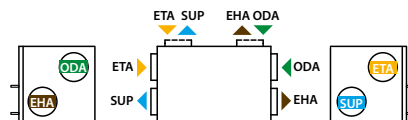

▶ ODA – outdoor intake ▶ SUP – supply air ▶ ETA – extract indoor ▶ EHA – exhaust air

Verso R 1500 F C5

Nominal air flow according to ErP 2018, m ³ /h	1500
Nominal air flow according to ErP 2018, l/s	417
Electric air heater capacity, kW / Δt, °C	6/11,7
Supply voltage HE, V	3~400
Maximal operating current HE, A	12,1
Power supply cable E, mm ²	5×2,5
Electric power input of the fan drive at maximum flow rate, W	350
Noise power level, L _{WA} , dB(A)	53
Noise pressure level, L _{PA} , dB(A), (3 m)	41
Filters dimensions B×H×L, mm	472×402×96
Unit dimensions B×H×L, mm	1050×485×1807
Panel thickness, mm	50
Maintenance space, mm	660
Unit weight, kg	195



Performance

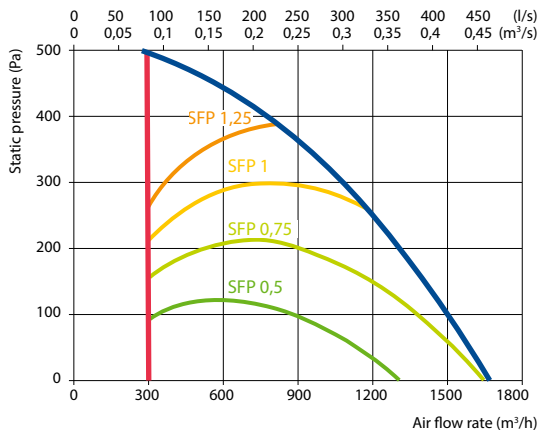

Temperature efficiency

Outside temperature, °C	Winter					Summer		
	-23	-15	-10	-5	0	25	30	35
After heat exchanger, °C	13,2	14,8	15,7	16,7	17,7	22,6	23,6	24,6

Indoor +22 °C, 20 % RH

Hot water duct air heater *

	Winter		
	80/60	70/50	60/40
Capacity, kW	4,9	4,9	4,9
Flow rate, dm ³ /h	213	212	211
Pressure drop, kPa	10,9	8,9	9
Temperature in/out, °C	12,3 / 22,0		
Maximal capacity, kW	13,8	11,3	8,7
Connection, "	½		

* Option

Shown as right (R1)

View from inspection side

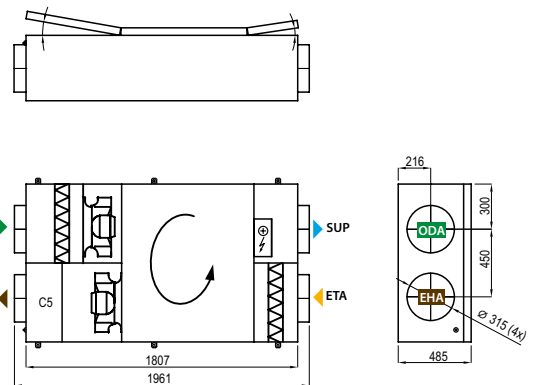

Shown as left (L1)



▶ ODA – outdoor intake ▶ SUP – supply air ▶ ETA – extract indoor ▶ EHA – exhaust air

Accessories

Closing damper	AGUJ-M-315+LF24/LM24
Silencer	ODA/EHA AGS-315-100-900-M
	SUP/ETA AGS-315-100-1200-M
Water heater	DH-315
PPU	PPU-HW-3R-15-1,6-W2
Water cooler	DCW-1,4-9
2-way valve	VVP47.20-4,0+SSF161.05HF
DX cooler	DCF-1,4-10
Cooling unit	MOU 36HFN8a+KA8140

Mounting positions

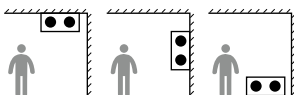

Verso R 1700 U C5

Nominal air flow according to ErP 2018, m ³ /h	1799
Nominal air flow according to ErP 2018, l/s	500
Electric air heater capacity, kW / Δt, °C	4,5/6,6
Supply voltage HE, V	3~400
Supply voltage HW, V	1~230
Maximal operating current HE, A	13,3
Maximal operating current HW, A	7,1
Power supply cable E, mm ²	5×2,5
Power supply cable W, mm ²	3×1,5
Electric power input of the fan drive at maximum flow rate, W	470
Noise power level, L _{WA} , dB(A)	55
Noise pressure level, L _{pA} , dB(A), (3 m)	45
Filters dimensions B×H×L, mm	800×450×46
Unit dimensions B×H×L, mm	910×1000×1485
Panel thickness, mm	50
Maintenance space, mm	800
Unit weight, kg	220



Performance

Verso R 1700 UH with standard equipment

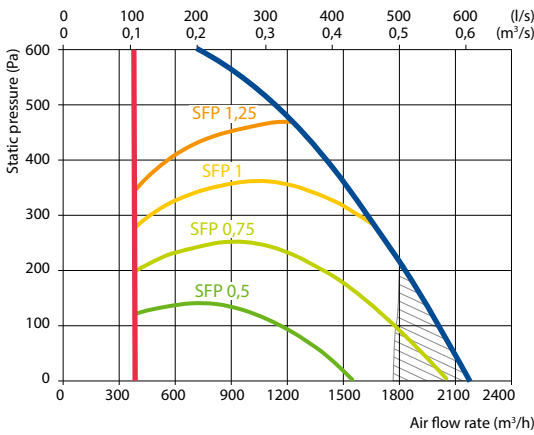

Does not conform to ErP2018 requirements

Accessories

Closing damper	H	SRU-M-300x400+LF24/LM24
	V	SRU-M-400x300+LF24/LM24
Silencer	ODA/EHA	STS-IVR3BA-600-300-700-S
	SUP/ETA	STS-IVR3BA-600-300-1250-S
PPU		PPU-HW-3R-15-1,6-W2
Water cooler		DCW-1,6-11
2-way valve		VVP47.20-4,0+SSF161.05HF
DX cooler		DCF-1,6-11
Cooling unit		MOU 36HFN8a+KA8140

Temperature efficiency

	Winter					Summer		
Outside temperature, °C	-23	-15	-10	-5	0	25	30	35
After heat exchanger, °C	11,5	13,4	14,6	15,7	16,9	22,7	23,9	25,0
Indoor +22 °C, 20 % RH								

Changeover water/ DX heating – cooling exchanger (HCW/HCDX)

	Winter	Summer	Winter	Summer
Water temperature in/out, °C	60/40	7/12	–	–
Condensation/evaporation T, °C	–	–	45	45/5
Capacity, kW	6,4	10,5	6,4	12,4
Maximal capacity, kW	13,8	11,9	9,9	14,7
Pressure drop, kPa	1	5,2	–	–
Air temperature in/out, °C	11,5 / 22	30 / 18	11,5 / 22	30 / 18
Connection, "/ mm	1		% / 22	

Shown as right (R1)

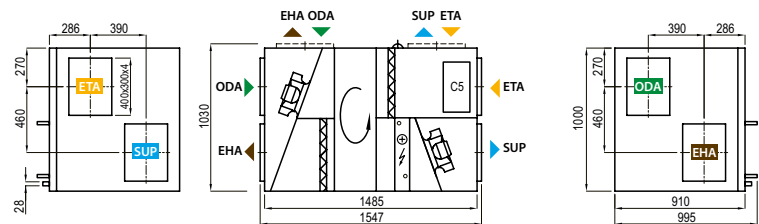

Shown as left (L1)

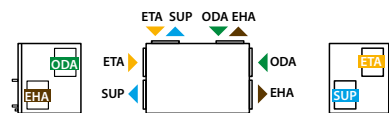

▶ ODA – outdoor intake ▶ SUP – supply air ▶ ETA – extract indoor ▶ EHA – exhaust air

Verso R 2000 U C5

Nominal air flow according to ErP 2018, m ³ /h	2159
Nominal air flow according to ErP 2018, l/s	600
Electric air heater capacity, kW / Δt, °C	7,5/8,4
Supply voltage HE, V	3~400
Supply voltage HW, V	1~230
Maximal operating current HE, A	16,9
Maximal operating current HW, A	6,3
Power supply cable E, mm ²	5×2,5
Power supply cable W, mm ²	3×1,5
Electric power input of the fan drive at maximum flow rate, W	650
Noise power level, L _{WA} , dB(A)	56
Noise pressure level, L _{PA} , dB(A), (3 m)	46
Filters dimensions B×H×L, mm	800×450×46
Unit dimensions B×H×L, mm	910×1000×1485
Panel thickness, mm	50
Maintenance space, mm	800
Unit weight, kg	210



Performance

Verso R 2000 UH with standard equipment

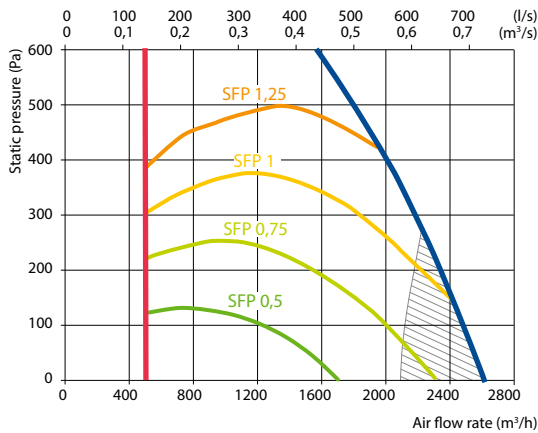

Does not conform to ErP2018 requirements

Accessories

Closing damper	H	SRU-M-300x400+LF24/LM24
	V	SRU-M-400x300+LF24/LM24
Silencer	ODA/EHA	STS-IVR3BA-600-400-700-S
	SUP/ETA	STS-IVR3BA-600-400-1250-S
PPU		PPU-HW-3R-15-2,5-W2
Water cooler		DCW-2,5-17
2-way valve		VVP45.25-6,3+SSB161.05HF
DX cooler		DCF-2,5-17
Cooling unit		MOU-55HFN8a+KA8140

Temperature efficiency

	Winter					Summer		
Outside temperature, °C	-23	-15	-10	-5	0	25	30	35
After heat exchanger, °C	10,3	12,4	13,7	15,0	16,3	22,8	24,1	25,4
Indoor +22 °C, 20 % RH								

Changeover water/ DX heating – cooling exchanger (HCW/HCDX)

	Winter		Summer	
Water temperature in/out, °C	60/40	7/12	-	-
Condensation/evaporation T, °C	-	-	45	45/5
Capacity, kW	8,5	12,7	7,1	12,4
Maximal capacity, kW	16,4	13,3	10,3	14,7
Pressure drop, kPa	1	7,5	-	-
Air temperature in/out, °C	10,3 / 22	30 / 18,0	10,3 / 22	30 / 18
Connection, "/ mm	1		5/8 / 22	

Shown as right (R1)

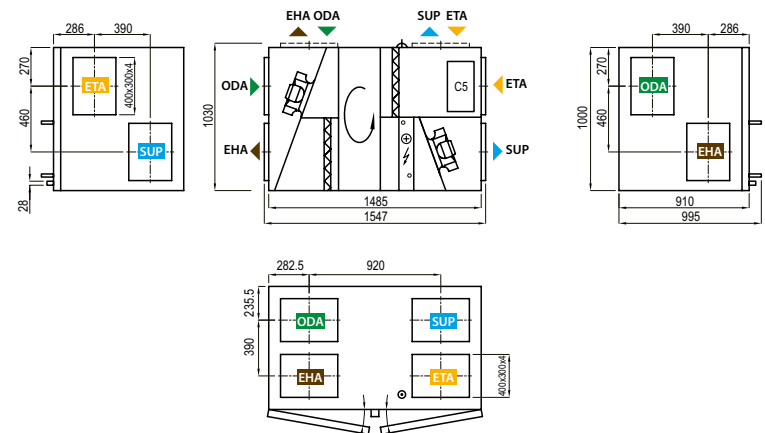

Shown as left (L1)

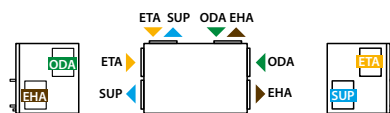

▶ ODA – outdoor intake ▶ SUP – supply air ▶ ETA – extract indoor ▶ EHA – exhaust air

Verso R 2000 F C5

Nominal air flow according to ErP 2018, m ³ /h	2070
Nominal air flow according to ErP 2018, l/s	575
Electric air heater capacity, kW / Δt, °C	7,5/9,3
Supply voltage HE, V	3~400
Supply voltage HW, V	1~230
Maximal operating current HE, A	16,8
Maximal operating current HW, A	6,3
Power supply cable E, mm ²	5×2,5
Power supply cable W, mm ²	3×1,5
Electric power input of the fan drive at maximum flow rate, W	670
Noise power level, L _{WA} , dB(A)	59
Noise pressure level, L _{pA} , dB(A), (3 m)	48
Filters dimensions B×H×L, mm	560×420×96
Unit dimensions B×H×L, mm	1210×527×2060
Panel thickness, mm	50
Maintenance space, mm	400
Unit weight, kg	280



Performance

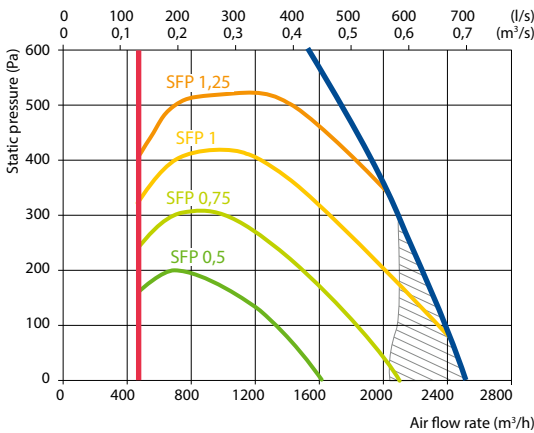

Does not conform to ErP2018 requirements

Accessories

Closing damper	AGUJ-M-355-LF24/LM24
Silencer	ODA/EHA AGS-355-100-900-M
	SUP/ETA AGS-355-100-1200-M
Water heater	DH-355
PPU	PPU-HW-3R-15-1,6-W2
Water cooler	DCW-2,0-13
Water heater-cooler	DHCW-355
2-way valve	VVP47.20-4,0+SSF161.05HF
DX cooler	DCF-2,0-14
Cooling unit	MOU-48HFN8a+KA8140

Mounting positions

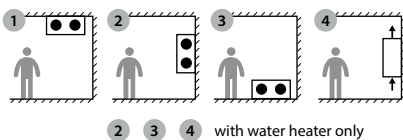

2 3 4 with water heater only

Temperature efficiency

Outside temperature, °C	Winter					Summer		
	-23	-15	-10	-5	0	25	30	35
After heat exchanger, °C	14,9	16,2	17,0	17,8	18,5	22,5	23,3	24,0

Indoor +22 °C, 20 % RH

Hot water duct air heater *

Water temperature in/out, °C	Winter		
	80/60	70/50	60/40
Capacity, kW	5,0	5,0	5,0
Flow rate, dm ³ /h	221	220	219
Pressure drop, kPa	12,2	12,3	12,4
Temperature in/out, °C	14,9/22		
Maximal capacity, kW	17,2	13,9	10,5
Connection, "	1/2		

* Option

Shown as right (R1)

View from inspection side

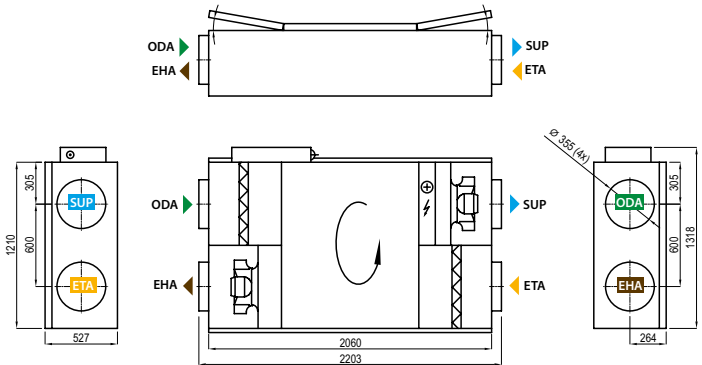

Shown as left (L1)

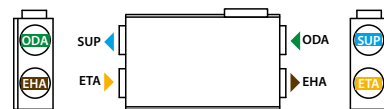

▶ ODA – outdoor intake ▶ SUP – supply air ▶ ETA – extract indoor ▶ EHA – exhaust air

Verso R 2500 H C5

Nominal air flow according to ErP 2018, m ³ /h	2807
Nominal air flow according to ErP 2018, l/s	780
Electric air heater capacity, kW / Δt, °C	7,5/7,8
Supply voltage HE, V	3~400
Supply voltage HW, V	1~230
Maximal operating current HE, A	18,8
Maximal operating current HW, A	8,3
Power supply cable E, mm ²	5×4
Power supply cable W, mm ²	3×1,5
Electric power input of the fan drive at maximum flow rate, W	520
Noise power level, L _{WA} , dB(A)	59
Noise pressure level, L _{PA} , dB(A), (3 m)	45
Filters dimensions B×H×L, mm	792×392-10×500
Unit dimensions B×H×L, mm	1000×1000×1606
Panel thickness, mm	50
Maintenance space, mm	900
Unit weight, kg	289



Performance

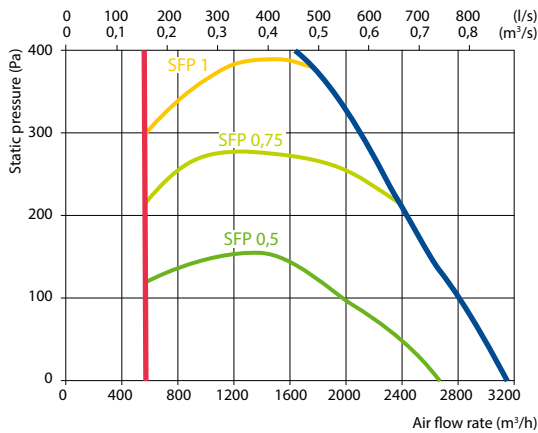

Temperature efficiency

Outside temperature, °C	Winter					Summer		
	-23	-15	-10	-5	0	25	30	35
After heat exchanger, °C	10,4	12,5	13,7	15,0	16,3	22,8	24,1	25,4

Indoor +22 °C, 20 % RH

Hot water air heater

	Winter		
	80/60	70/50	60/40
Water temperature in/out, °C			
Capacity, kW	11	11	11
Flow rate, dm ³ /h	484	482	480
Pressure drop, kPa	1,7	1,7	1,7
Temperature in/out, °C	10,4 / 22,0		
Maximal capacity, kW	22,9	18,4	13,7
Connection, "	½		

Accessories

Closing damper	SRU-M-700x300+LF24/LM24
Silencer	ODA/EHA STS-IVR3BA-800-300-700-S
	SUP/ETA STS-IVR3BA-800-300-1250-S
PPU	PPU-HW-3R-15-2,5-W2
Water cooler	DCW-2,5-17
2-way valve	VVP45.25-6,3+SSB161.05HF
DX cooler	DCF-2,5-17
Cooling unit	MOU-55HFN8a+KA8140

Shown as right (R1)

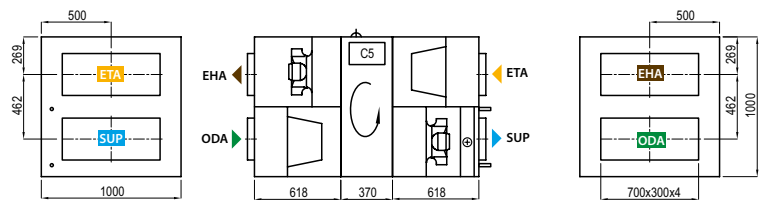

Shown as left (L1)

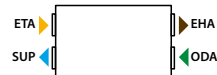

Shown as left (L2)

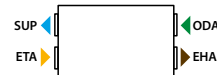

Shown as right (R2)

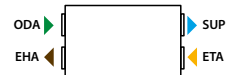

▶ ODA – outdoor intake ▶ SUP – supply air ▶ ETA – extract indoor ▶ EHA – exhaust air

Verso R 3000 U C5

Nominal air flow according to ErP 2018, m ³ /h	3662
Nominal air flow according to ErP 2018, l/s	1017
Electric air heater capacity, kW / Δt, °C	9/6,5
Supply voltage HE, V	3~400
Supply voltage HW, V	3~400
Maximal operating current HE, A	19,8
Maximal operating current HW, A	7,1
Power supply cable E, mm ²	5x2,5
Power supply cable W, mm ²	5x1,5
Electric power input of the fan drive at maximum flow rate, W	850
Noise power level, L _{WA} , dB(A)	51
Noise pressure level, L _{pA} , dB(A), (3 m)	40
Filters dimensions BxHxL, mm	525x510x46
Unit dimensions BxHxL, mm	1150x1150x2100
Panel thickness, mm	50
Maintenance space, mm	1000
Unit weight, kg	456



Performance

Verso R 3000 UH with standard equipment

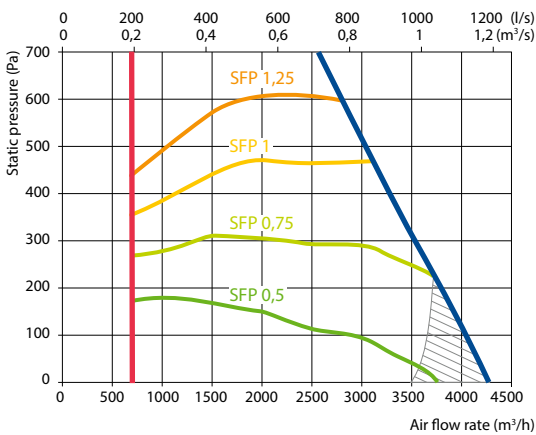

Does not conform to ErP2018 requirements

Accessories

Closing damper	H	SRU-M-400x500+LF24/LM24
	V	SRU-M-500x400+LF24/LM24
Silencer	ODA/EHA	STS-IVR3BA-600-500-700-S
	SUP/ETA	STS-IVR3BA-600-500-1250-S
PPU		PPU-HW-3R-15-2,5-W2
Water cooler		DCW-3,0-20
2-way valve		VVP45.25-6,3+SSB161.05HF
DX cooler		DCF-3,0-20-2
Cooling unit		2xMOU36HFN8a+KA8140

Temperature efficiency

Outside temperature, °C	Winter					Summer		
	-23	-15	-10	-5	0	25	30	35
After heat exchanger, °C	11,0	13,0	14,2	15,4	16,6	22,7	24,0	25,2

Indoor +22 °C, 20 % RH

Changeover water/ DX heating – cooling exchanger (HCW/HCDX)

	Winter		Summer	
	Winter	Summer	Winter	Summer
Water temperature in/out, °C	60/40	7/12	-	-
Condensation/evaporation T, °C	-	-	45	45/5
Capacity, kW	13,4	22,3	11,5	19,6
Maximal capacity, kW	27,7	22,9	20,4	22,9
Pressure drop, kPa	1,0	19,4	-	-
Air temperature in/out, °C	11,0 / 22	30 / 18,0	11,0 / 22	30 / 18
Connection, "/ mm		1	3/4 / 22	

Shown as right (R1)

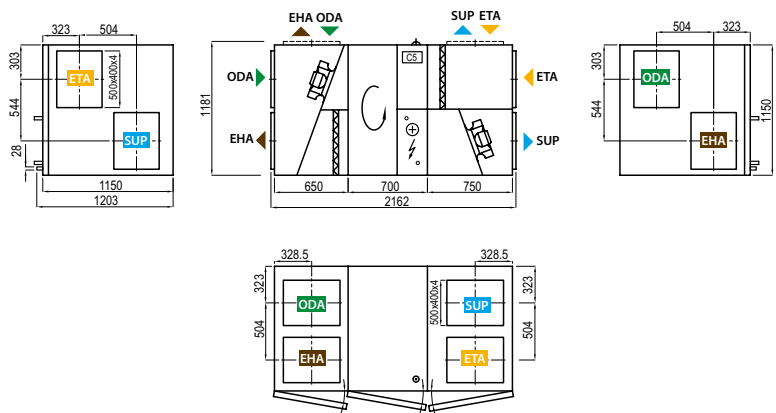

Shown as left (L1)



▶ ODA – outdoor intake ▶ SUP – supply air ▶ ETA – extract indoor ▶ EHA – exhaust air

Verso R 3000 F C5

Nominal air flow according to ErP 2018, m³/h	3150
Nominal air flow according to ErP 2018, l/s	875
Electric air heater capacity, kW / Δt, °C	9/7,9
Supply voltage HE, V	3~400
Supply voltage HW, V	3~400
Maximal operating current HE, A	19,8
Maximal operating current HW, A	7,1
Power supply cable E, mm²	5x4
Power supply cable W, mm²	5x1,5
Electric power input of the fan drive at maximum flow rate, W	720
Noise power level, L _{WA} , dB(A)	60
Noise pressure level, L _{PA} , dB(A), (3 m)	49
Filters dimensions BxHxL, mm	560x540x96
Unit dimensions BxHxL, mm	1210x648x2160
Panel thickness, mm	50
Maintenance space, mm	600
Unit weight, kg	289



Performance

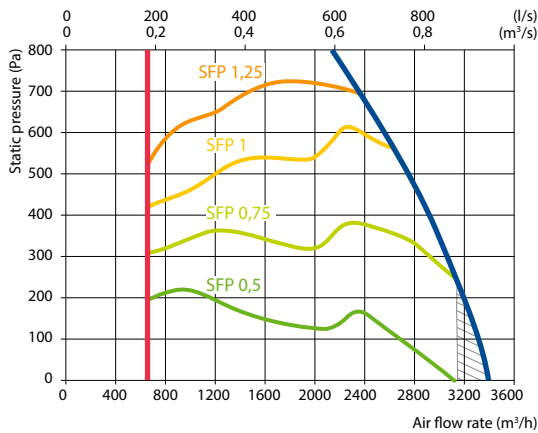

Does not conform to ErP2018 requirements

Accessories

Closing damper	SRU-M-500x400+LF24/LM24
Silencer	ODA/EHA STS-IVR3BA-600-400-700-S SUP/ETA STS-IVR3BA-600-400-1250-S
Water heater	SVK-700x400-2R
PPU	PPU-HW-3R-15-1.6-W2
Water cooler	DCW-3,0-20
2-way valve	VVP45.25-6.3+SSB161.05HF
DX cooler	DCF-3,0-20-2
Cooling unit	2xMOU-36HFN8a+KA8140

Mounting positions

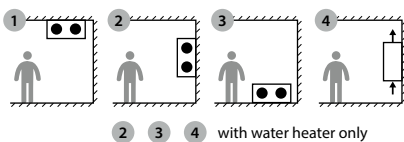

Temperature efficiency

Outside temperature, °C	Winter					Summer		
	-23	-15	-10	-5	0	25	30	35
After heat exchanger, °C	12,8	14,5	15,5	16,5	17,5	22,6	23,6	24,6

Indoor +22 °C, 20 % RH

Hot water duct air heater *

Water temperature in/out, °C	Winter		
	80/60	70/50	60/40
Capacity, kW	10,2	10,2	10,2
Flow rate, dm³/h	450	448	446
Pressure drop, kPa	8,1	8,2	8,3
Temperature in/out, °C	12,8 / 22,0		
Maximal capacity, kW	26,0	21,1	16,1
Connection, "	½		

* Option

Shown as right (R1)

View from inspection side

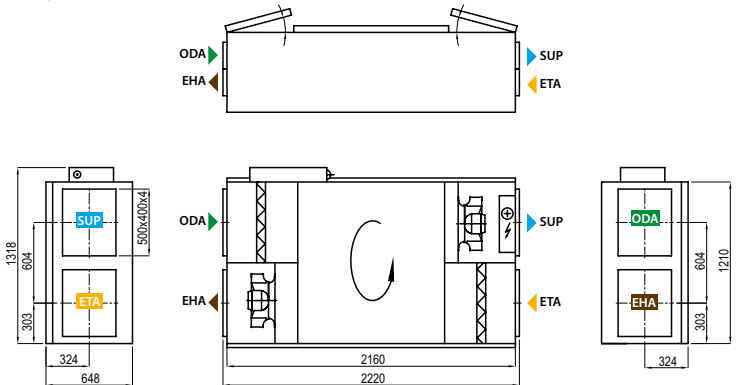

Shown as left (L1)

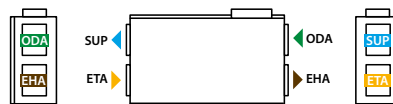

▶ ODA – outdoor intake ▶ SUP – supply air ▶ ETA – extract indoor ▶ EHA – exhaust air

Verso R 4000 U C5

Nominal air flow according to ErP 2018, m ³ /h	3754
Nominal air flow according to ErP 2018, l/s	1043
Electric air heater capacity, kW / Δt, °C	15/8,3
Supply voltage HE, V	3~400
Supply voltage HW, V	3~400
Maximal operating current HE, A	31,1
Maximal operating current HW, A	9,7
Power supply cable E, mm ²	5×6
Power supply cable W, mm ²	5×1,5
Electric power input of the fan drive at maximum flow rate, W	1830
Noise power level, L _{WA} , dB(A)	47
Noise pressure level, L _{pA} , dB(A), (3 m)	36
Filters dimensions B×H×L, mm	525×510×46
Unit dimensions B×H×L, mm	1150×1150×2100
Panel thickness, mm	50
Maintenance space, mm	1000
Unit weight, kg	518



Performance

Verso R 4000 UH with standard equipment

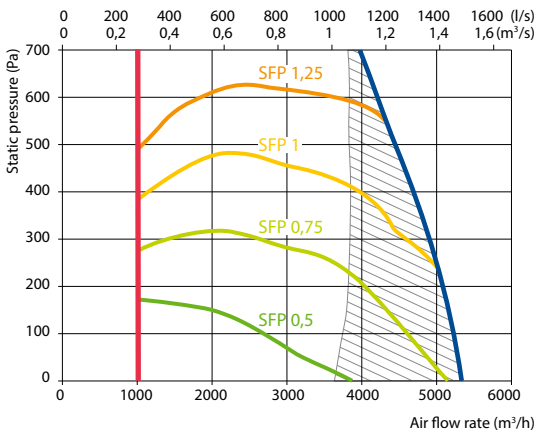

Does not conform to ErP2018 requirements

Accessories

Closing damper	H	SRU-M-400x500+LF24/LM24
	V	SRU-M-500x400+LF24/LM24
Silencer	ODA/EHA	STS-IVR3BA-800-500-700-S
	SUP/ETA	STS-IVR3BA-800-500-1250-S
PPU		PPU-HW-3R-25-6.3-W2
Water cooler		DCW-4,5-30
2-way valve		VVP45.25-10+SSC161.05HF
DX cooler		DCF-4,5-31-2
Cooling unit		2xMOU-55HFN8a+KA8140

Temperature efficiency

	Winter					Summer		
Outside temperature, °C	-23	-15	-10	-5	0	25	30	35
After heat exchanger, °C	10,9	12,9	14,1	15,4	16,6	22,7	24,0	25,2

Indoor +22 °C, 20 % RH

Changeover water/ DX heating – cooling exchanger (HCW/HCDX)

	Winter	Summer	Winter	Summer
Water temperature in/out, °C	60/40	7/12	–	–
Condensation/evaporation T, °C	–	–	45	45/5
Capacity, kW	13,9	23,0	13,1	24,1
Maximal capacity, kW	28,3	23,3	17,6	26,8
Pressure drop, kPa	1	20,5	–	–
Air temperature in/out, °C	10,9 / 22	30 / 18,0	10,9 / 22	30 / 18,0
Connection, " / mm		1	2x½" / 2x22	

Shown as right (R1)

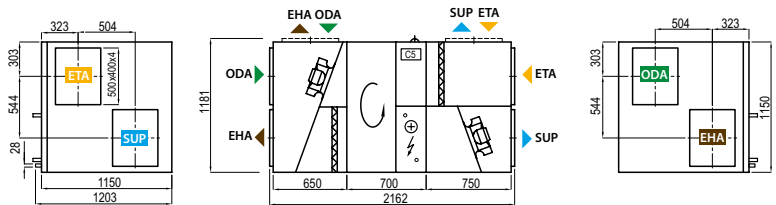

Shown as left (L1)

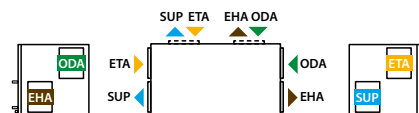

▶ ODA – outdoor intake ▶ SUP – supply air ▶ ETA – extract indoor ▶ EHA – exhaust air

Verso R 5000 V C5

Nominal air flow according to ErP 2018, m ³ /h	5160
Nominal air flow according to ErP 2018, l/s	1433
Electric air heater capacity, kW / Δt, °C	15/8,2
Supply voltage HE, V	3~400
Supply voltage HW, V	3~400
Maximal operating current HE, A	29,5
Maximal operating current HW, A	8,1
Power supply cable E, mm ²	5x6
Power supply cable W, mm ²	5x1,5
Electric power input of the fan drive at maximum flow rate, W	1215
Noise power level, L _{WA} , dB(A)	56
Noise pressure level, L _{PA} , dB(A), (3 m)	44
Filters dimensions BxHxL, mm	650x630x92
Unit dimensions BxHxL, mm	1405x1400x1900
Panel thickness, mm	50
Maintenance space, mm	1300
Unit weight, kg	600



Performance

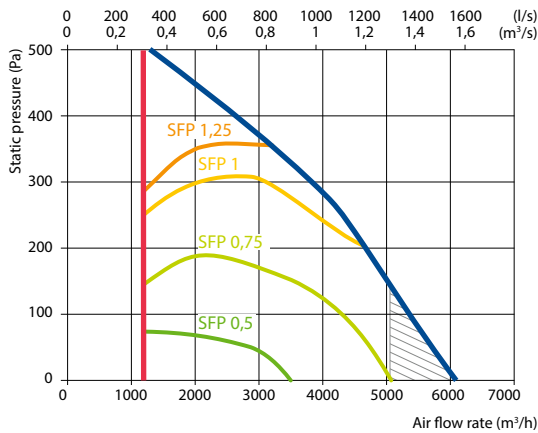

Does not conform to ErP2018 requirements

Accessories

Closing damper	SRU-M-1100x300+LF24/LM24
Silencer	ODA/EHA STS-IXY5BU-1250-300-700-S SUP/ETA STS-11XAMR-1250-300-1250-S
PPU	PPU-HW-3R-20-4-W2
Water cooler	DCW-4,5-30
2-way valve	VVP45.25-10.0+SSC161.05HF
DX cooler	DCF-4,5-31-2
Cooling unit	2xMOU-55HFN8a+KA8140

Temperature efficiency

	Winter					Summer		
Outside temperature, °C	-23	-15	-10	-5	0	25	30	35
After heat exchanger, °C	14,9	16,2	17	17,8	18,5	22,5	23,3	24,0
Indoor +22 °C, 20 % RH								

Changeover water/ DX heating – cooling exchanger (HCW/HCDX)

	Winter	Summer	Winter	Summer
Water temperature in/out, °C	60/40	7/12		
Condensation/evaporation T, °C	-	-	45	45/5
Capacity, kW	11,8	31,1	11,08	34,1
Maximal capacity, kW	41,4	40,1	26,6	38,6
Pressure drop, kPa	1,0	22,4	-	-
Air temperature in/out, °C	15/22	30/18	15/22	30/18
Connection, "/ mm		¼	2x½ / 2x22	

Shown as right (R1)

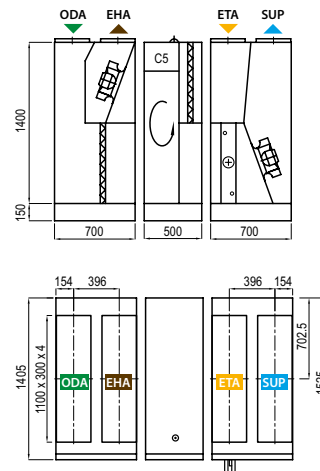

Shown as left (L1)

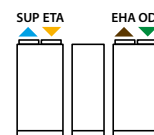

▶ ODA – outdoor intake ▶ SUP – supply air ▶ ETA – extract indoor ▶ EHA – exhaust air

Verso R 5000 H C5

Nominal air flow according to ErP 2018, m ³ /h	5355
Nominal air flow according to ErP 2018, l/s	1488
Supply voltage HW, V	3~400
Maximal operating current HW, A	13,1
Power supply cable W, mm ²	5×2,5
Electric power input of the fan drive at maximum flow rate, W	1000
Noise power level, L _{WA,r} dB(A)	63
Noise pressure level, L _{PA,r} dB(A), (3 m)	50
Filters dimensions B×H×L, mm	592×592-8×500
Unit dimensions B×H×L, mm	1300×1300×1872
Panel thickness, mm	50
Maintenance space, mm	1200
Unit weight, kg	442



Performance

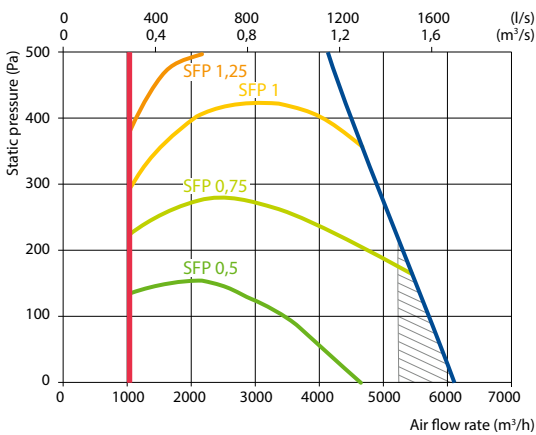

Does not conform to ErP2018 requirements

Accessories

Closing damper	SRU-M-1000x500+LF24/LM24
Silencer	ODA/EHA STS-IVR3BA-1000-500-700-S SUP/ETA STS-IVR3BA-1000-500-1250-S
PPU	PPU-HW-3R-20-4,0-W2
Water cooler	DCW-4,5-30
2-way valve	VVP45.25-10.0+SSC161.05HF
DX cooler	DCF-4,5-31-2
Cooling unit	2xMOU-55HFN8a+KA8140

Temperature efficiency

Outside temperature, °C	Winter					Summer		
	-23	-15	-10	-5	0	25	30	35
After heat exchanger, °C	10,5	12,6	13,8	15,1	16,4	22,8	24,0	25,3
Indoor +22 °C, 20 % RH								

Hot water air heater

	Winter		
	80/60	70/50	60/40
Water temperature in/out, °C			
Capacity, kW	20,8	20,8	20,8
Flow rate, dm ³ /h	913	909	905
Pressure drop, kPa	3,8	3,8	3,8
Temperature in/out, °C	10,5 / 22,0	10,5 / 22,0	10,5 / 22,0
Maximal capacity, kW	38,9	30,5	21,4
Connection, "	½		

Shown as right (R1)

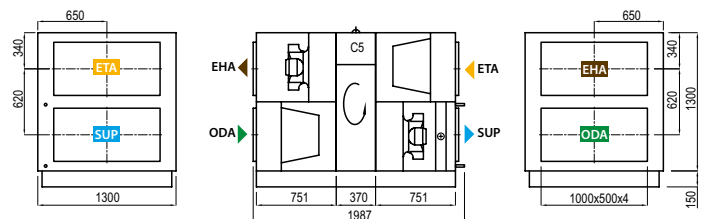

Shown as left (L1)

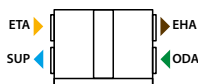

Shown as left (L2)

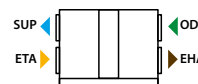

Shown as right (R2)

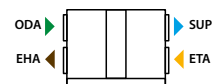

ODA – outdoor intake SUP – supply air ETA – extract indoor EHA – exhaust air

Verso R 7000 V C5

Nominal air flow according to ErP 2018, m ³ /h	6405
Nominal air flow according to ErP 2018, l/s	1779
Electric air heater capacity, kW / Δt, °C	15/6,3
Supply voltage HE, V	3~400
Supply voltage HW, V	3~400
Maximal operating current HE, A	37,7
Maximal operating current HW, A	16
Power supply cable E, mm ²	5×10
Power supply cable W, mm ²	5×2,5
Electric power input of the fan drive at maximum flow rate, W	1170
Noise power level, L _{WA} , dB(A)	55
Noise pressure level, L _{PA} , dB(A), (3 m)	44
Filters dimensions B×H×L, mm	3 x 467×701-8×500 2 x 700×547-8×320
Unit dimensions B×H×L, mm	1505×1535×2200
Panel thickness, mm	50
Maintenance space, mm	1400
Unit weight, kg	700



Performance

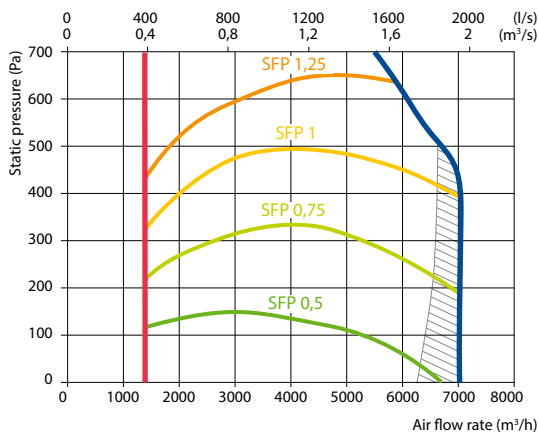

Does not conform to ErP2018 requirements

Accessories

Closing damper	SRU-M-1200x300+LF24/LM24
Silencer	ODA/EHA STS-IVR3BA-1200-600-700-S SUP/ETA STS-IVR3BA-1200-600-1250-S
PPU	PPU-HW-3R-20-4,0-W2
Water cooler	DCW-7,0-47
2-way valve	VVP45.32-16.0+SSC161.05HF
DX cooler	DCF-7,0-48-3
Cooling unit	3xMOU-55HFN8a+KA8140

Temperature efficiency

	Winter					Summer		
Outside temperature, °C	-23	-15	-10	-5	0	25	30	35
After heat exchanger, °C	11,2	13,1	14,3	15,5	16,7	22,7	23,9	25,1
Indoor +22 °C, 20 % RH								

Changeover water/ DX heating – cooling exchanger (HCW/HCDX)

	Winter	Summer	Winter	Summer
Water temperature in/out, °C	60/40	7/12	-	-
Condensation/evaporation T, °C	-	-	45	45/5
Capacity, kW	15,2	39,8	15,2	44,4
Maximal capacity, kW	46,2	44,5	28,1	68,5
Pressure drop, kPa	1	25,3	-	-
Air temperature in/out, °C	15/22	30/18	15/22	30/18
Connection, "/ mm	1¼		2x¾ / 2x22	

Shown as right (R1)

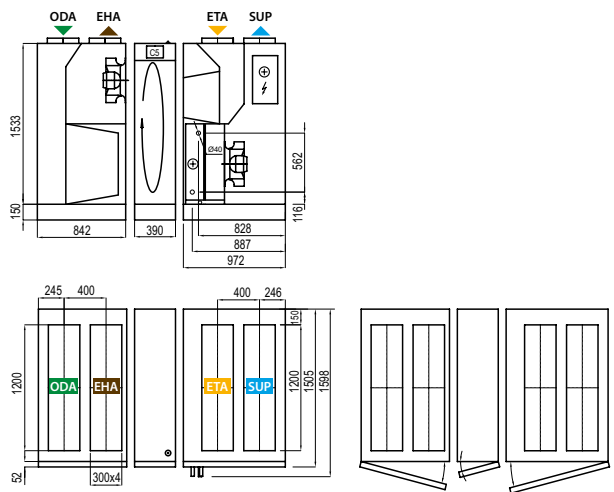

Shown as left (L1)

▶ ODA – outdoor intake ▶ SUP – supply air ▶ ETA – extract indoor ▶ EHA – exhaust air

Verso R 7000 H C5

Nominal air flow according to ErP 2018, m ³ /h	6657
Nominal air flow according to ErP 2018, l/s	1489
Supply voltage HW, V	3~400
Maximal operating current HW, A	12,9
Power supply cable W, mm ²	5x2,5
Electric power input of the fan drive at maximum flow rate, W	1340
Noise power level, L _{WA,r} dB(A)	59
Noise pressure level, L _{PA,r} dB(A), (3 m)	48
Filters dimensions BxHxL, mm	592x592-8x500
Unit dimensions BxHxL, mm	1525x1675x1980
Panel thickness, mm	45
Maintenance space, mm	1500
Unit weight, kg	765



Performance

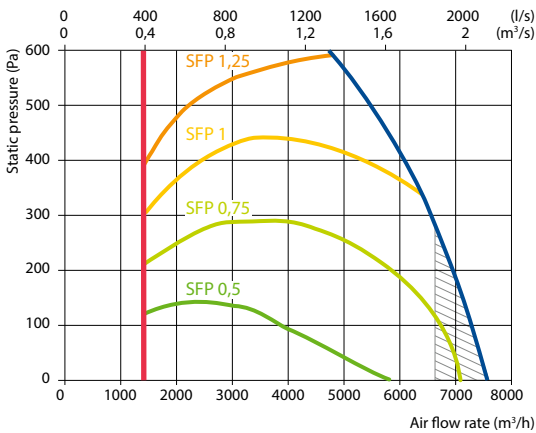

Does not conform to ErP2018 requirements

Accessories

Closing damper	SRU-M-1200x600+LF24/LM24
Silencer	ODA/EHA STS-IVR3BA-1200-600-700-S SUP/ETA STS-IVR3BA-1200-600-1250-S
PPU	PPU-HW-3R-20-4,0-W2
Water cooler	DCW-7,0-47
2-way valve	VVP45.32-16.0+SSC161.05HF
DX cooler	DCF-7,0-48-3
Cooling unit	3xMOU-55HFN8a+KA8140

Temperature efficiency

Outside temperature, °C	Winter					Summer		
	-23	-15	-10	-5	0	25	30	35
After heat exchanger, °C	11,1	13,0	14,2	15,4	16,7	22,7	24,0	25,2
Indoor +22 °C, 20 % RH								

Hot water air heater

	Winter		
	80/60	70/50	60/40
Water temperature in/out, °C			
Capacity, kW	24,5	24,5	24,5
Flow rate, dm ³ /h	1076	1071	1067
Pressure drop, kPa	6,7	6,8	7
Temperature in/out, °C	11,1/22,0		
Maximal capacity, kW	56,8	46,5	36
Connection, "	1	1	1

Shown as right (R1)

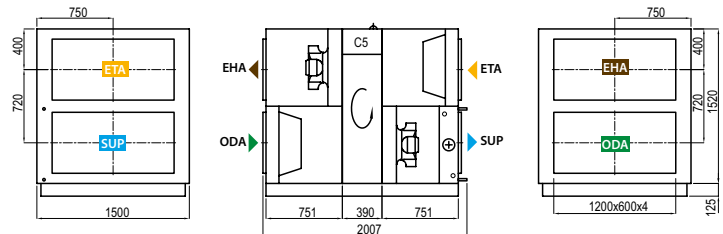

Shown as left (L1)

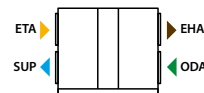

▶ ODA – outdoor intake ▶ SUP – supply air ▶ ETA – extract indoor ▶ EHA – exhaust air

Verso CF Standard

Air handling units with counterflow plate heat exchangers

Sizes and capacities of Verso CF Standard units

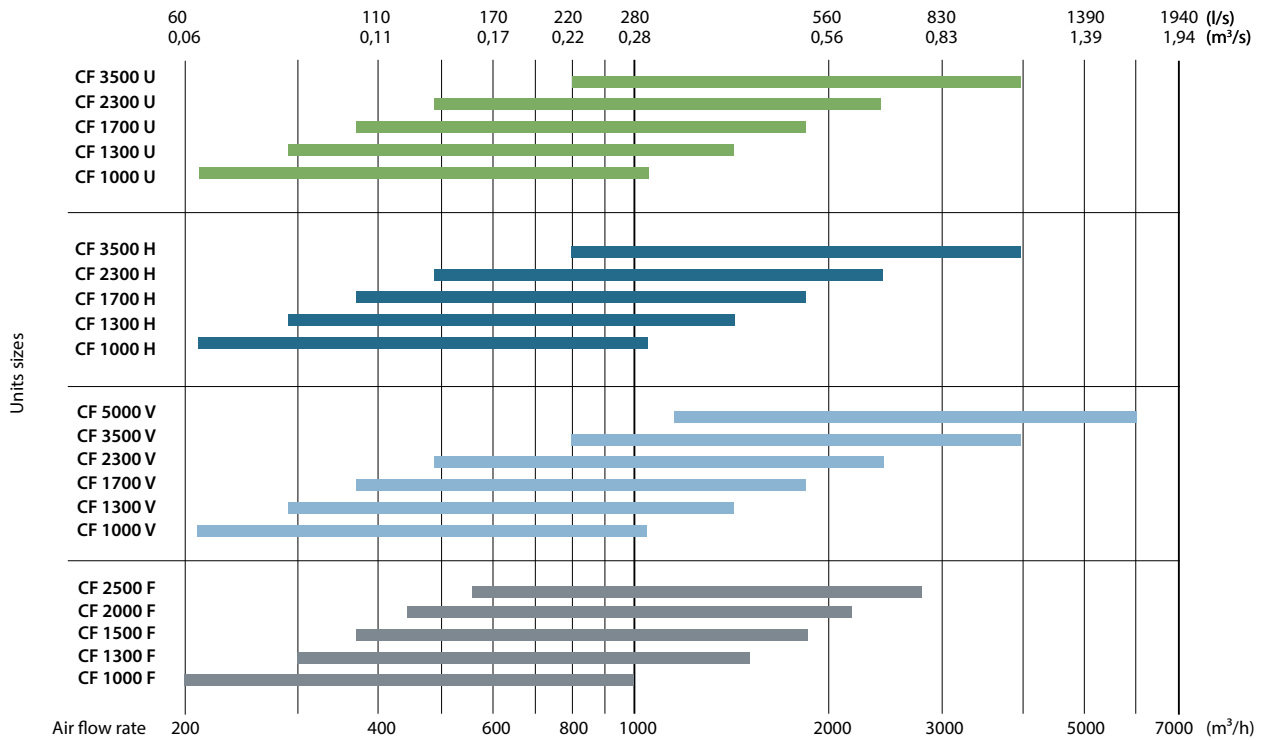

Modifications of Verso CF Standard units

Unit	Heat exchanger Condensing	Multi-level frost prevention	Supply / exhaust air filter class ePM1 60 % / ePM10 50 %	Heater			Cooler		Inspection side		Control system C5
				HE	HW	HCW	DCW	HCDX	R1	L1	
Verso CF 1000 U	●		●	○		○	△	○	○	○	●
Verso CF 1000 H / V	●		●	○	○		△	△	○	○	●
Verso CF 1000 F	●		●	●	△	△	△	△	○	○	●
Verso CF 1300 U	●		●	○		○	△	○	○	○	●
Verso CF 1300 H / V	●		●	○	○		△	△	○	○	●
Verso CF 1300 F	●		●	●	△	△	△	△	○	○	●
Verso CF 1500 F	●		●	●	△	△	△	△	○	○	●
Verso CF 1700 U	●		●	○		○	△	○	○	○	●
Verso CF 1700 H / V	●		●	○	○		△	△	○	○	●
Verso CF 2000 F	●		●	●	△	△	△	△	○	○	●
Verso CF 2300 U	●	○	●	○		○	△	○	○	○	●
Verso CF 2300 H / V	●	○	●	○	○		△	△	○	○	●
Verso CF 2500 F	●		●	●	△		△	△	○	○	●
Verso CF 3500 U	●	○	●	○		○	△	○	○	○	●
Verso CF 3500 H / V	●	○	●	○	○		△	△	○	○	●
Verso CF 5000 V	●	○	●	○	○	○		○	○	○	●

● standard equipment

○ possible choice

△ ordered separately duct heater/cooler

The markings are explained on p. 7.

Verso CF 1000 U C5

Nominal air flow according to ErP 2018, m ³ /h	1055
Nominal air flow according to ErP 2018, l/s	293
Electric air heater capacity, kW / Δt, °C	4,5/12,5
Supply voltage HE, V	3~400
Supply voltage HW, V	1~230
Maximal operating current HE, A	9,5
Maximal operating current HW, A	3,3
Power supply cable E, mm ²	5×1,5
Power supply cable W, mm ²	3×1,5
Electric power input of the fan drive at maximum flow rate, W	178
Noise power level, L _{WA} , dB(A)	54
Noise pressure level, L _{pA} , dB(A), (3 m)	43
Filters dimensions B×H×L, mm	800×400×46
Unit dimensions B×H×L, mm	910×905×1810
Panel thickness, mm	50
Maintenance space, mm	800
Unit weight, kg	269



Performance

Verso CF 1000 UH with standard equipment

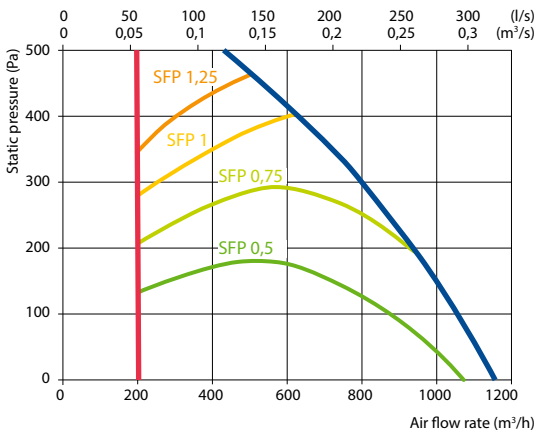

Temperature efficiency

	Winter					Summer		
Outside temperature, °C	-23	-15	-10	-5	0	25	30	35
After heat exchanger, °C	15,2	16,0	16,8	17,1	18,0	22,6	23,5	24,7

Indoor +22 °C, 20 % RH

Changeover water/ DX heating – cooling exchanger (HCW/HCDX)

	Winter	Summer	Winter	Summer
Water temperature in/out, °C	60/40	7/12	–	–
Condensation/evaporation T, °C	–	–	45	45/5
Capacity, kW	2,4	6,8	2,4	7,3
Maximal capacity, kW	9,0	9,1	5,7	10
Pressure drop, kPa	1	31,6	–	–
Air temperature in/out, °C	15,2 / 22	30 / 18	15,2 / 22	30 / 18
Connection, " / mm		½		½ / 22

Accessories

Closing damper	AGUJ-M-315+LF24/LM24
Silencer	ODA/EHA AGS-315-100-900-M
	SUP/ETA AGS-315-100-1200-M
PPU	PPU-HW-3R-15-0,63-W2
Water cooler	DCW-0,9-6
2-way valve	VVP47.15-2,5+SSF161.05HF
DX cooler	DCF-0,9-6
Cooling unit	MOU-18HFN8a+KA8140

Shown as right (R1)

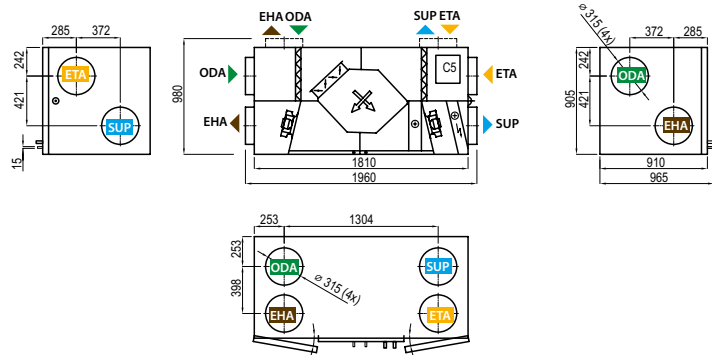

Shown as left (L1)



▶ ODA – outdoor intake ▶ SUP – supply air ▶ ETA – extract indoor ▶ EHA – exhaust air

Verso CF 1000 F C5

Nominal air flow according to ErP 2018, m ³ /h	868
Nominal air flow according to ErP 2018, l/s	241
Electric air heater capacity, kW / Δt, °C	3/10,1
Supply voltage HE, V	3~400
Supply voltage HW, V	1~230
Maximal operating current HE, A	7,3
Maximal operating current HW, A	3,3
Power supply cable E, mm ²	5×1,5
Power supply cable W, mm ²	3×1,5
Electric power input of the fan drive at maximum flow rate, W	168
Noise power level, L _{WA} , dB(A)	54
Noise pressure level, L _{PA} , dB(A), (3 m)	42
Filters dimensions B×H×L, mm	550×420×46
Unit dimensions B×H×L, mm	1100×527×1650
Panel thickness, mm	50
Maintenance space, mm	400
Unit weight, kg	173



Performance

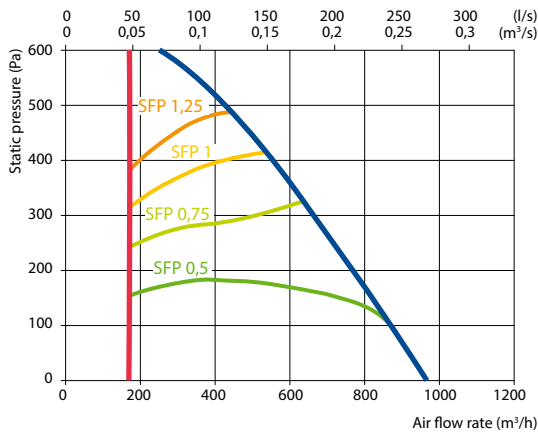

Temperature efficiency

Outside temperature, °C	Winter					Summer		
	-23	-15	-10	-5	0	25	30	35
After heat exchanger, °C	17,2	17,4	17,8	18,1	18,7	22,6	23,6	24,7

Indoor +22 °C, 20 % RH

Hot water duct air heater *

	Winter		
	80/60	70/50	60/40
Water temperature in/out, °C			
Capacity, kW	1,4	1,4	1,4
Flow rate, dm ³ /h	60	60	60
Pressure drop, kPa	2,3	2,3	2,4
Temperature in/out, °C	17,2/22		
Maximal capacity, kW	8,8	7,0	5,2
Connection, "	½		

* Option

Shown as right (R1)

View from inspection side

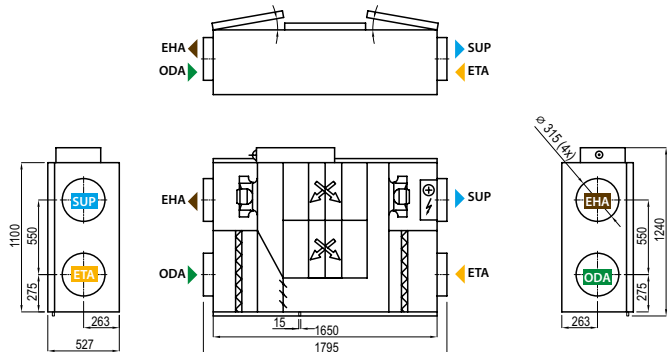

Shown as left (L1)

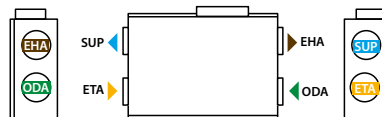

▶ ODA – outdoor intake ▶ SUP – supply air ▶ ETA – extract indoor ▶ EHA – exhaust air

Accessories

Closing damper	AGUJ-M-315+LF24/LM24
Silencer	ODA/EHA AGS-315-100-900-M SUP/ETA AGS-315-100-1200-M
Water heater	DH-315
PPU	PPU-HW-3R-15-1,0-W2
Water cooler	DCW-0,9-6
Water heater-cooler	DHCW-315
2-way valve	VVP47.15-2,5+SSF161.05HF
DX cooler	DCF-0,9-6
Cooling unit	MOU-18HFN8a+KA8140

Mounting positions



Verso CF 1300 U C5

Nominal air flow according to ErP 2018, m ³ /h	1341
Nominal air flow according to ErP 2018, l/s	373
Electric air heater capacity, kW / Δt, °C	4,5/9,3
Supply voltage HE, V	3~400
Supply voltage HW, V	1~230
Maximal operating current HE, A	12,7
Maximal operating current HW, A	6,5
Power supply cable E, mm ²	5×1,5
Power supply cable W, mm ²	3×1,5
Electric power input of the fan drive at maximum flow rate, W	370
Noise power level, L _{WA} , dB(A)	59
Noise pressure level, L _{pA} , dB(A), (3 m)	48
Filters dimensions B×H×L, mm	800×400×46
Unit dimensions B×H×L, mm	910×905×1810
Panel thickness, mm	50
Maintenance space, mm	800
Unit weight, kg	225



Performance

Verso CF 1300 UH with standard equipment

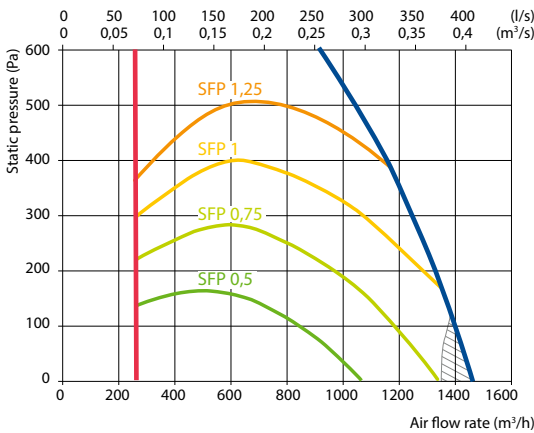

Does not conform to ErP2018 requirements

Accessories

Closing damper	AGUJ-M-315+LF24/LM24
Silencer	ODA/EHA AGS-315-100-900-M
	SUP/ETA AGS-315-100-1200-M
PPU	PPU-HW-3R-15-1-W2
Water cooler	DCW-1,4-9
2-way valve	VVP47.20-4,0+SSF161.05HF
DX cooler	DCF-1,4-10
Cooling unit	MOU-36HFN8a+KA8140

Temperature efficiency

	Winter					Summer		
Outside temperature, °C	-23	-15	-10	-5	0	25	30	35
After heat exchanger, °C	14,6	15,5	16,4	16,8	17,8	22,6	23,6	24,6
Indoor +22 °C, 20 % RH								

Changeover water/ DX heating – cooling exchanger (HCW/HCDX)

	Winter	Summer	Winter	Summer
Water temperature in/out, °C	60/40	7/12	–	–
Condensation/evaporation T, °C	–	–	45	45/5
Capacity, kW	3,4	8,6	3,4	9,3
Maximal capacity, kW	11,0	10,7	6,8	11,5
Pressure drop, kPa	1	49,5	–	–
Air temperature in/out, °C	14,6 / 22	30 / 18	14,6 / 22	30 / 18
Connection, " / mm	½		½ / 22	

Shown as right (R1)

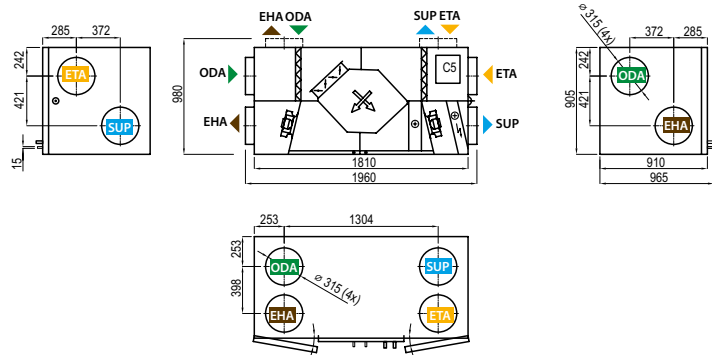

Shown as left (L1)

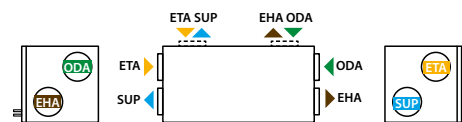

▶ ODA – outdoor intake ▶ SUP – supply air ▶ ETA – extract indoor ▶ EHA – exhaust air

Verso CF 1300 F C5

Nominal air flow according to ErP 2018, m ³ /h	1317
Nominal air flow according to ErP 2018, l/s	366
Electric air heater capacity, kW / Δt, °C	4,5/9,5
Supply voltage HE, V	3~400
Supply voltage HW, V	1~230
Maximal operating current HE, A	12,7
Maximal operating current HW, A	6,5
Power supply cable E, mm ²	5×1,5
Power supply cable W, mm ²	3×1,5
Electric power input of the fan drive at maximum flow rate, W	360
Noise power level, L _{WA} , dB(A)	59
Noise pressure level, L _{pA} , dB(A), (3 m)	48
Filters dimensions B×H×L, mm	550×420×46
Unit dimensions B×H×L, mm	1100×527×1650
Panel thickness, mm	50
Maintenance space, mm	400
Unit weight, kg	175



Performance

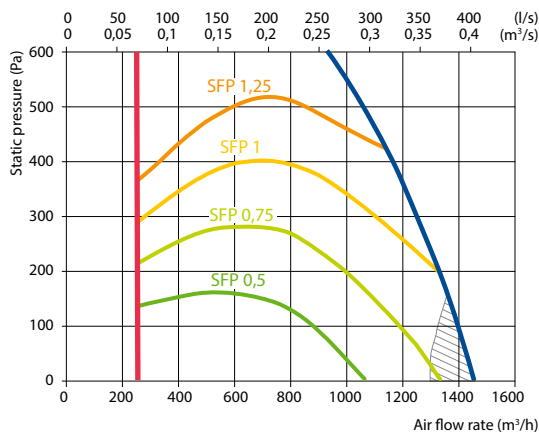

Does not conform to ErP2018 requirements

Accessories

Closing damper	AGUJ-M-315+LF24/LM24
Silencer	ODA/EHA AGS-315-100-900-M SUP/ETA AGS-315-100-1200-M
Water heater	DH-315
PPU	PPU-HW-3R-15-1-W2
Water cooler	DCW-1,4-9
Water heater-cooler	DHCW-315
2-way valve	VVP47.20-4,0+SSF161.05HF
DX cooler	DCF-1,4-10
Cooling unit	MOU-36HFN8a+KA8140

Mounting positions



Temperature efficiency

Outside temperature, °C	Winter					Summer		
	-23	-15	-10	-5	0	25	30	35
After heat exchanger, °C	16,2	16,5	16,8	17,4	18,1	22,6	23,7	24,9

Indoor +22 °C, 20 % RH

Hot water duct air heater *

	Winter		
	80/60	70/50	60/40
Capacity, kW	2,6	2,6	2,6
Flow rate, dm ³ /h	115	115	114
Pressure drop, kPa	4,4	4,4	4,4
Temperature in/out, °C	16,2 / 22,0		
Maximal capacity, kW	11,9	9,5	7,1
Connection, "	½		

* Option

Shown as right (R1)
View from inspection side

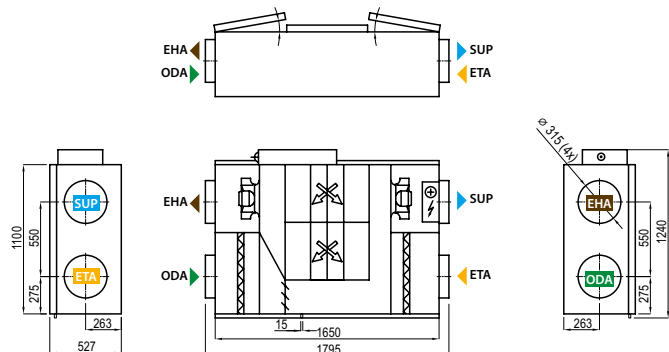

Shown as left (L1)

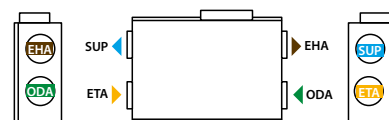

▶ ODA – outdoor intake ▶ SUP – supply air ▶ ETA – extract indoor ▶ EHA – exhaust air

Verso CF 1500 F C5

Nominal air flow according to ErP 2018, m ³ /h	1459
Nominal air flow according to ErP 2018, l/s	405
Electric air heater capacity, kW / Δt, °C	4,5/7,9
Supply voltage HE, V	3~400
Supply voltage HW, V	1~230
Maximal operating current HE, A	13,3
Maximal operating current HW, A	7,1
Power supply cable E, mm ²	5×2,5
Power supply cable W, mm ²	3×1,5
Electric power input of the fan drive at maximum flow rate, W	460
Noise power level, L _{WA} , dB(A)	57
Noise pressure level, L _{pA} , dB(A), (3 m)	46
Filters dimensions B×H×L, mm	550×420×46
Unit dimensions B×H×L, mm	1100×527×1650
Panel thickness, mm	50
Maintenance space, mm	400
Unit weight, kg	190



Performance

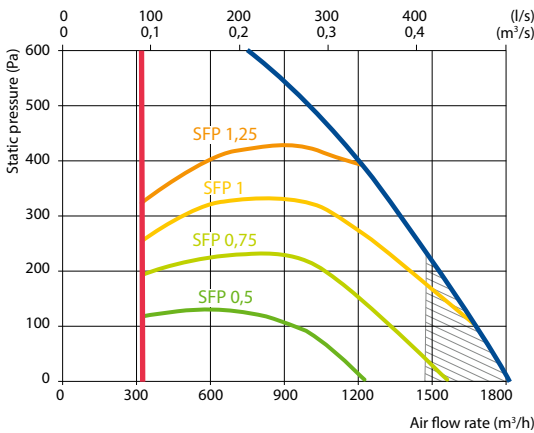

Does not conform to ErP2018 requirements

Accessories

Closing damper	AGUJ-M-315+LF24/LM24
Silencer	ODA/EHA AGS-315-100-900-M
	SUP/ETA AGS-315-100-1200-M
Water heater	DH-315
PPU	PPU-HW-3R-15-1-W2
Water cooler	DCW-1,6-11
Water heater-cooler	DHCW-315
2-way valve	VVP47.20-4,0+SSF161.05HF
DX cooler	DCF-1,6-11
Cooling unit	MOU-36HFN8a+KA8140

Mounting positions



Temperature efficiency

	Winter					Summer		
Outside temperature, °C	-23	-15	-10	-5	0	25	30	35
After heat exchanger, °C	16,0	16,3	16,6	17,3	18,0	22,6	23,8	25,0
Indoor +22 °C, 20 % RH								

Hot water duct air heater *

	Winter		
Water temperature in/out, °C	80/60	70/50	60/40
Capacity, kW	3,0	3,0	3,0
Flow rate, dm ³ /h	131	131	131
Pressure drop, kPa	5,2	5,2	5,3
Temperature in/out, °C	16,0 / 22,0		
Maximal capacity, kW	12,6	10,1	7,6
Connection, "	½		

* Option

Shown as right (R1)

View from inspection side

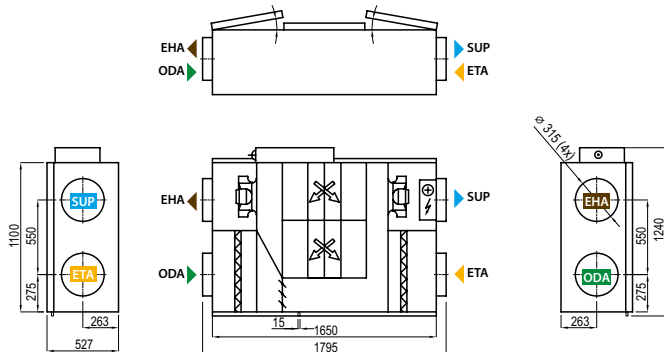

Shown as left (L1)

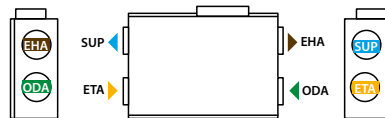

▶ ODA – outdoor intake ▶ SUP – supply air ▶ ETA – extract indoor ▶ EHA – exhaust air

Verso CF 1700 U C5

Nominal air flow according to ErP 2018, m ³ /h	1416
Nominal air flow according to ErP 2018, l/s	393
Electric air heater capacity, kW / Δt, °C	4,5/8,0
Supply voltage HE, V	3~400
Supply voltage HW, V	1~230
Maximal operating current HE, A	13,3
Maximal operating current HW, A	7,1
Power supply cable E, mm ²	5×2,5
Power supply cable W, mm ²	3×1,5
Electric power input of the fan drive at maximum flow rate, W	465
Noise power level, L _{WA} , dB(A)	57
Noise pressure level, L _{PA} , dB(A), (3 m)	46
Filters dimensions B×H×L, mm	800×400×46
Unit dimensions B×H×L, mm	910×905×1810
Panel thickness, mm	50
Maintenance space, mm	800
Unit weight, kg	243



Performance

Verso CF 1700 UH with standard equipment

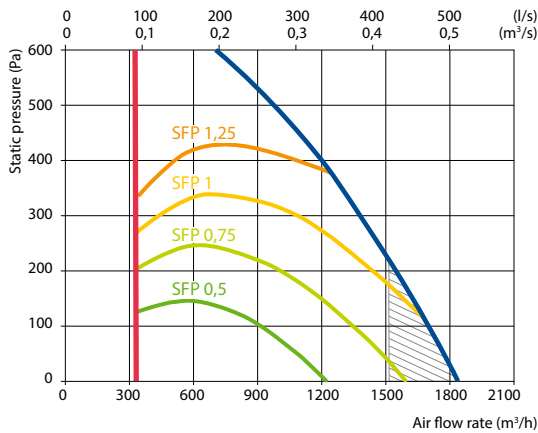

Does not conform to ErP2018 requirements

Accessories

Closing damper	AGUJ-M-315+LF24/LM24
Silencer	ODA/EHA AGS-315-100-900-M SUP/ETA AGS-315-100-1200-M
PPU	PPU-HW-3R-15-1,6-W2
Water cooler	DCW-1,6-11
2-way valve	VVP47.20-4,0+SSF161.05HF
DX cooler	DCF-1,6-11
Cooling unit	MOU-36HFN8a+KA8140

Temperature efficiency

	Winter					Summer		
Outside temperature, °C	-23	-15	-10	-5	0	25	30	35
After heat exchanger, °C	14,4	15,3	16,2	16,6	17,6	22,6	23,6	24,7

Indoor +22 °C, 20 % RH

Changeover water/ DX heating – cooling exchanger (HCW/HCDX)

	Winter	Summer	Winter	Summer
Water temperature in/out, °C	60/40	7/12	-	-
Condensation/evaporation T, °C	-	-	45	45/5
Capacity, kW	3,6	9,0	3,7	10,0
Maximal capacity, kW	11,4	11,0	6,5	12,1
Pressure drop, kPa	1	53,8	-	-
Air temperature in/out, °C	14,4 / 22	30 / 18	14,4 / 22	30 / 18
Connection, "/ mm		½	¾ / 22	

Shown as right (R1)

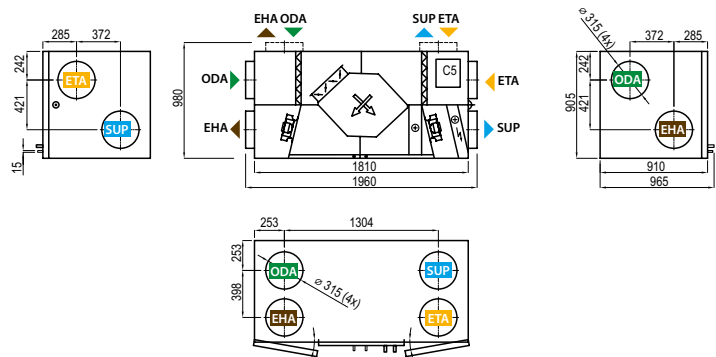

Shown as left (L1)

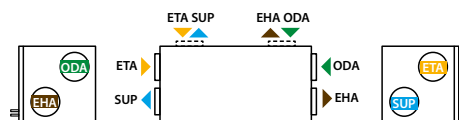

▶ ODA – outdoor intake ▶ SUP – supply air ▶ ETA – extract indoor ▶ EHA – exhaust air

Verso CF 2000 F C5

Nominal air flow according to ErP 2018, m ³ /h	1995
Nominal air flow according to ErP 2018, l/s	554
Electric air heater capacity, kW / Δt, °C	7,5/10,1
Supply voltage HE, V	3~400
Supply voltage HW, V	1~230
Maximal operating current HE, A	16,6
Maximal operating current HW, A	11,7
Power supply cable E, mm ²	5x2,5
Power supply cable W, mm ²	3x1,5
Electric power input of the fan drive at maximum flow rate, W	450
Noise power level, L _{WA} , dB(A)	56
Noise pressure level, L _{pA} , dB(A), (3 m)	45
Filters dimensions BxHxL, mm	800x375x96
Unit dimensions BxHxL, mm	1600x480x1750
Panel thickness, mm	50
Maintenance space, mm	550
Unit weight, kg	235



Performance

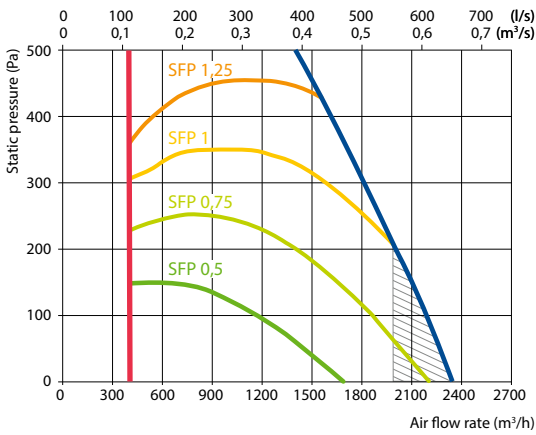

Does not conform to ErP2018 requirements

Accessories

Closing damper	SRU-M-600x300+LF24/LM24
Silencer	ODA/EHA STS-BQUNBM-700x400-700-S SUP/ETA STS-IB6GBC-700x400-1250-S
Water heater	SVK-700x400-2
PPU	PPU-HW-3R-15-1,6-W2
Water cooler	DCW-2,0-13
2-way valve	VVP47.20-4,0+SSF161.05HF
DX cooler	DCF-2,0-14
Cooling unit	MOU-48HFN8a+KA8140

Mounting positions



Temperature efficiency

	Winter					Summer		
Outside temperature, °C	-23	-15	-10	-5	0	25	30	35
After heat exchanger, °C	14,5	15,4	15,9	16,7	17,7	22,6	23,5	24,5

Indoor +22 °C, 20 % RH

Hot water duct air heater *

	Winter		
Water temperature in/out, °C	80/60	70/50	60/40
Capacity, kW	5,0	5,0	5,0
Flow rate, dm ³ /h	221	220	219
Pressure drop, kPa	1,0	1,0	1,0
Temperature in/out, °C	14,5 / 22,0		
Maximal capacity, kW	22,5	18,0	13,4
Connection, "	¾		

* Option

Shown as right (R1)

View from inspection side

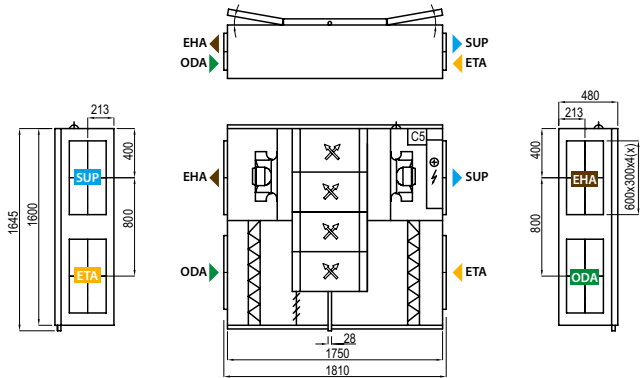

Shown as left (L1)

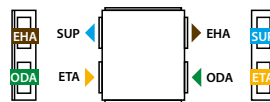

▶ ODA – outdoor intake ▶ SUP – supply air ▶ ETA – extract indoor ▶ EHA – exhaust air

Verso CF 2300 U C5

Nominal air flow according to ErP 2018, m ³ /h	1980
Nominal air flow according to ErP 2018, l/s	550
Electric air heater capacity, kW / Δt, °C	7,5/9,3
Supply voltage HE, V	3~400
Supply voltage HW, V	1~230
Maximal operating current HE, A	16,8
Maximal operating current HW, A	6,3
Power supply cable E, mm ²	5×2,5
Power supply cable W, mm ²	3×1,5
Electric power input of the fan drive at maximum flow rate, W	660
Noise power level, L _{WA} , dB(A)	57
Noise pressure level, L _{PA} , dB(A), (3 m)	47
Filters dimensions B×H×L, mm	800×400×46
Unit dimensions B×H×L, mm	910×905×2000
Panel thickness, mm	50
Maintenance space, mm	800
Unit weight, kg	250



Performance

Verso CF 2300 UH with standard equipment

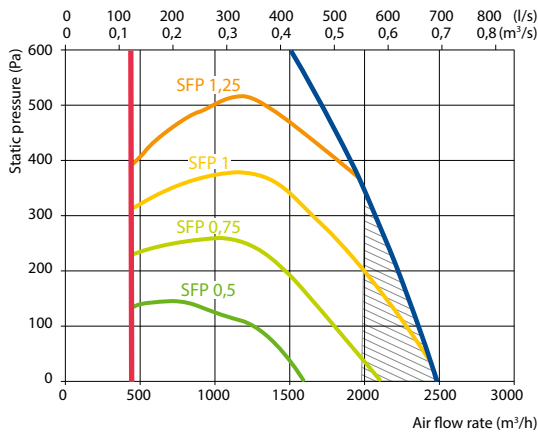

Does not conform to ErP2018 requirements

Accessories

Closing damper	H	SRU-M-300x400+LF24/LM24
	V	SRU-M-400x300+LF24/LM24
Silencer	ODA/EHA	STS-IVR3BA-600-400-700-S
	SUP/ETA	STS-IVR3BA-600-400-1250-S
PPU		PPU-HW-3R-15-1,6-W2
Water cooler		DCW-2,5-17
2-way valve		VVP45.25-6,3+SSB161.05HF
DX cooler		DCF-2,5-17
Cooling unit		MOU-55HFN8a+KA8140

Temperature efficiency

Outside temperature, °C	Winter					Summer		
	-23	-15	-10	-5	0	25	30	35
After heat exchanger, °C	15,7	16,2	16,5	17,2	18,0	22,5	23,4	24,4

Indoor +22 °C, 20 % RH

Changeover water/ DX heating – cooling exchanger (HCW/HCDX)

	Winter		Summer	
	Winter	Summer	Winter	Summer
Water temperature in/out, °C	60/40	7/12	-	-
Condensation/evaporation T, °C	-	-	45	45/5
Capacity, kW	4,2	12,4	3,1	10,0
Maximal capacity, kW	13,4	12,9	6,9	12,0
Pressure drop, kPa	1	50	-	-
Air temperature in/out, °C	15,7 / 22	30/ 18,0	15,7 / 22	30 / 18
Connection, "/ mm		¾		½ / 22

Summer: +30 °C/ 50 %; HCW – 2200 m³/h; DX – 1450 m³/h

Shown as right (R1)

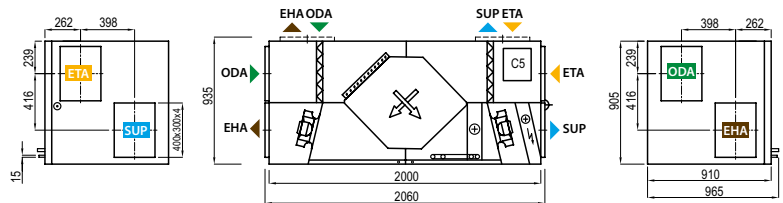

Shown as left (L1)

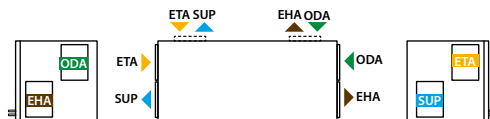

ODA – outdoor intake SUP – supply air ETA – extract indoor EHA – exhaust air

Verso CF 2500 F C5

Nominal air flow according to ErP 2018, m ³ /h	2542
Nominal air flow according to ErP 2018, l/s	706
Electric air heater capacity, kW / Δt, °C	7,5/8,3
Supply voltage HE, V	3~400
Supply voltage HW, V	1~230
Maximal operating current HE, A	16,9
Maximal operating current HW, A	6,3
Power supply cable E, mm ²	5×2,5
Power supply cable W, mm ²	3×1,5
Electric power input of the fan drive at maximum flow rate, W	640
Noise power level, L _{WA} , dB(A)	62
Noise pressure level, L _{pA} , dB(A), (3 m)	51
Filters dimensions B×H×L, mm	888×420×96
Unit dimensions B×H×L, mm	2000×528×1850
Panel thickness, mm	50
Maintenance space, mm	620
Unit weight, kg	340



Performance

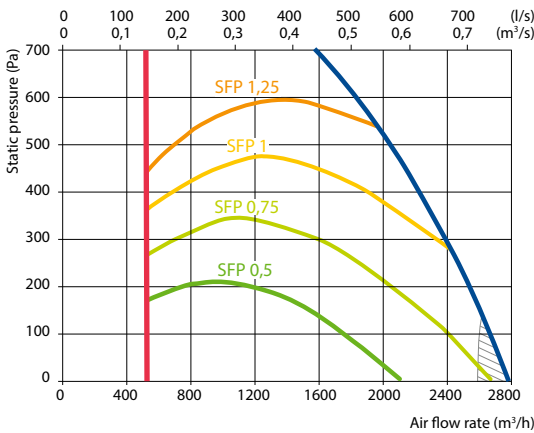

Does not conform to ErP2018 requirements

Accessories

Closing damper	SRU-M-700x300+LF24/LM24
Silencer	ODA/EHA STS-IVR3BA-800-300-700-S
	SUP/ETA STS-IVR3BA-800-300-1250-S
Water heater	SVK-700x400-2R
PPU	PPU-HW-3R-15-1,6-W2
Water cooler	DCW-2,5-17
2-way valve	VVP45.25-6,3+SSB161.05HF
DX cooler	DCF-2,5-17
Cooling unit	MOU-55HFN8a+KA8140

Mounting positions



Temperature efficiency

Outside temperature, °C	Winter					Summer		
	-23	-15	-10	-5	0	25	30	35
After heat exchanger, °C	13,9	14,9	15,9	16,6	17,6	22,6	23,6	24,7

Indoor +22 °C, 20 % RH

Hot water air heater *

	Winter		
	80/60	70/50	60/40
Water temperature in/out, °C			
Capacity, kW	7,0	7,0	7,0
Flow rate, dm ³ /h	311	309	308
Pressure drop, kPa	4,8	4,8	4,9
Temperature in/out, °C	13,9 / 22		
Maximal capacity, kW	22,3	18,0	13,6
Connection, "	½		

* Option

Shown as right (R1)

View from inspection side

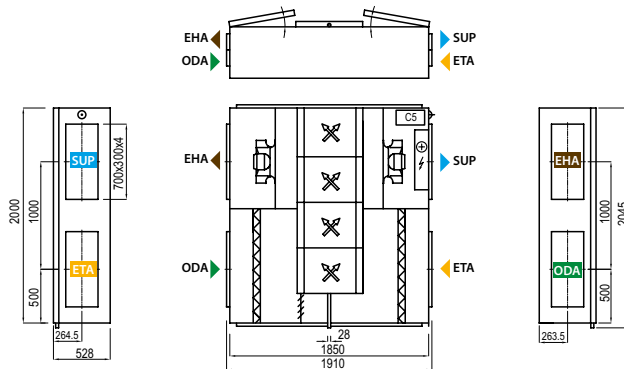

Shown as left (L1)



▶ ODA – outdoor intake ▶ SUP – supply air ▶ ETA – extract indoor ▶ EHA – exhaust air

Verso CF 3500 U C5

Nominal air flow according to ErP 2018, m ³ /h	3074
Nominal air flow according to ErP 2018, l/s	854
Electric air heater capacity, kW / Δt, °C	12/9,3
Supply voltage HE, V	3~400
Supply voltage HW, V	3~400
Maximal operating current HE, A	23,4
Maximal operating current HW, A	6,3
Power supply cable E, mm ²	5×4
Power supply cable W, mm ²	5×1,5
Electric power input of the fan drive at maximum flow rate, W	960
Noise power level, L _{WA} , dB(A)	54
Noise pressure level, L _{PA} , dB(A), (3 m)	43
Filters dimensions BxHxL, mm	525×510×46
Unit dimensions BxHxL, mm	1150×1150×2500
Panel thickness, mm	50
Maintenance space, mm	1000
Unit weight, kg	500



Performance

Verso CF 3500 UH with standard equipment

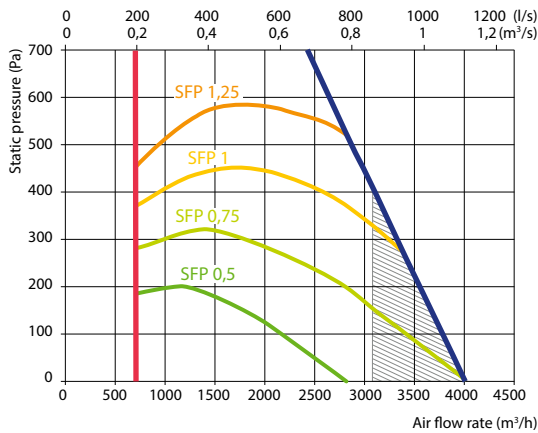

Does not conform to ErP2018 requirements

Accessories

Closing damper	H	SRU-M-400x500+LF24/LM24
	V	SRU-M-500x400+LF24/LM24
Silencer	ODA/EHA	STS-IVR3BA-800-500-700-S
	SUP/ETA	STS-IVR3BA-800-500-1250-S
PPU		PPU-HW-3R-15-2,5-W2
Water cooler		DCW-4,0-27
2-way valve		VVP45.25-6,3+SSB161.05HF
DX cooler		DCF-4,0-27-2
Cooling unit		2xMOU-48HFN8a+KA8140

Temperature efficiency

	Winter					Summer		
Outside temperature, °C	-23	-15	-10	-5	0	25	30	35
After heat exchanger, °C	14,0	15,0	15,9	16,3	17,4	22,6	23,7	24,8

Indoor +22 °C, 20 % RH

Changeover water/ DX heating – cooling exchanger (HCW/HCDX)

	Winter	Summer	Winter	Summer
Water temperature in/out, °C	60/40	7/12	-	-
Condensation/evaporation T, °C	-	-	45	45/5
Capacity, kW	9,5	8,4	8,2	21,8
Maximal capacity, kW	18,7	10,0	18,3	30,9
Pressure drop, kPa	3,6	25,1	-	-
Air temperature in/out, °C	14,0 / 22	30 / 24	14,0 / 22	30 / 18
Connection, "/ mm	¾		2x¾/2x22	

Summer: 30 °C / 50 %; DX/HCW – 3150 m³/h

Shown as right (R1)

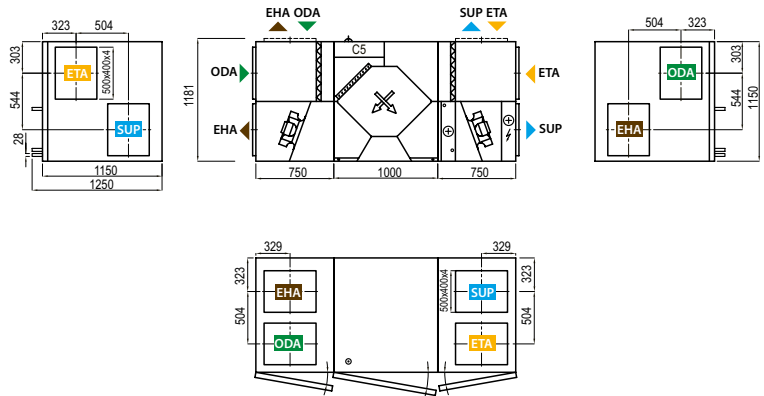

Shown as left (L1)

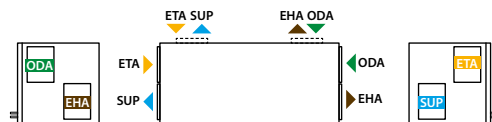

▶ ODA – outdoor intake ▶ SUP – supply air ▶ ETA – extract indoor ▶ EHA – exhaust air

Verso CF 5000 V C5

Nominal air flow according to ErP 2018, m ³ /h	5025
Nominal air flow according to ErP 2018, l/s	1396
Electric air heater capacity, kW / Δt, °C	15/9,8
Supply voltage HE, V	3~400
Supply voltage HW, V	3~400
Maximal operating current HE, A	29,7
Maximal operating current HW, A	8,3
Power supply cable E, mm ²	5×6
Power supply cable W, mm ²	5×1,5
Electric power input of the fan drive at maximum flow rate, W	1850
Noise power level, L _{WA} , dB(A)	52
Noise pressure level, L _{pA} , dB(A), (3 m)	41
Filters dimensions B×H×L, mm	650×450×92
Unit dimensions B×H×L, mm	1400×1541×2315
Panel thickness, mm	45
Maintenance space, mm	1 500
Unit weight, kg	680



Performance

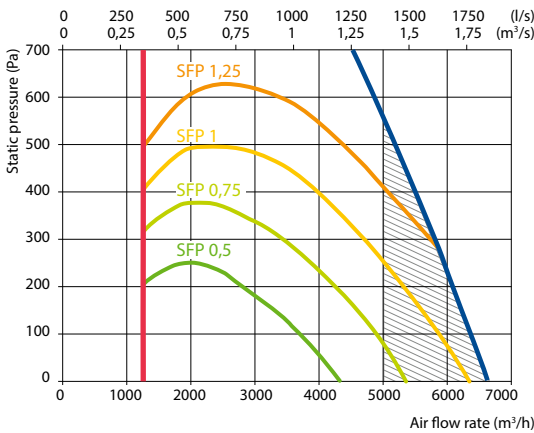

Does not conform to ErP2018 requirements

Accessories

Closing damper	SRU-M-1100x300
Silencer	ODA/EHA STS-IXY5BU-1250-300-700-S SUP/ETA STS-11XAMR-1250-300-1250-S
PPU	PPU-HW-3R-20-4-W2
Water cooler	DCW-4,5-30
2-way valve	VVP45.25-10.0+SSC161.05HF
DX cooler	DCF-4,5-31-2
Cooling unit	2xMOU-55HFN8a+KA8140

Temperature efficiency

Outside temperature, °C	Winter					Summer		
	-23	-15	-10	-5	0	25	30	35
After heat exchanger, °C	14,8	15,7	16,2	17	17,9	22,6	23,5	24,4

Indoor +22 °C, 20 % RH

Changeover water/ DX heating – cooling exchanger (HCW/HCDX)

	Winter		Summer	
	Winter	Summer	Winter	Summer
Water temperature in/out, °C	60/40	7/12	–	–
Condensation/evaporation T, °C	–	–	45	45/5
Capacity, kW	12,2	31,2	12,2	33,7
Maximal capacity, kW	40,6	38,6	25,7	35,2
Pressure drop, kPa	1	27,5	–	–
Air temperature in/out, °C	14,8 / 22	30 / 18	14,8 / 22	30 / 18
Connection, "/ mm	1 ¼		2x¾/2x22	

Shown as right (R1)

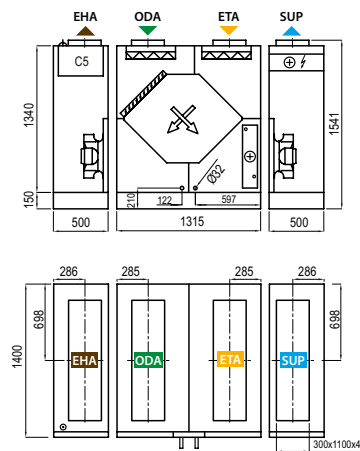

Shown as left (L1)

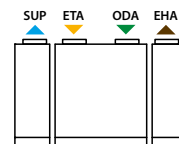

▶ ODA – outdoor intake ▶ SUP – supply air ▶ ETA – extract indoor ▶ EHA – exhaust air

Verso S Standard

False ceiling supply air handling units



Sizes and capacities of Verso S Standard units

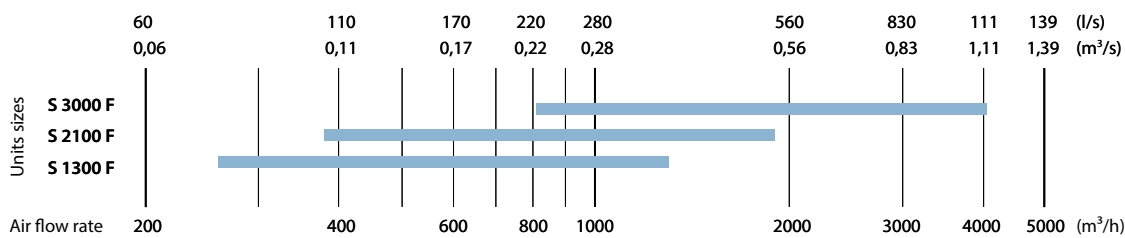

Modifications of Verso S Standard units

Unit	Supply air filter class	Heater		Cooler		Control system
	ePM1 60%	HE	HW	HCW	HCDX	C5
Verso S 1300 F	●	○	○	△	△	●
Verso S 2100 F	●	○	○	△	△	●
Verso S 3000 F	●		●	△	△	●

● standard equipment ○ possible choice △ ordered separately duct heater/cooler

The markings are explained on p. 7.

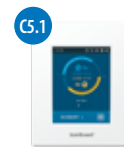

Technical data

Verso S unit	1300 F	2100 F	3000 F
Nominal air flow, m³/h	1347	1935	3915
Electric power input of the fan drive at reference flow rate, W	350	340	629
Sound pressure level L_{PA} , dB(A), distance from casing – 3 m	56	52	52
Filters dimensions B×H×L, mm	558×287×46	858×287×46	2×450×480×96
Unit weight, kg	46	73	130

Unit / dimension (mm)	L	L1	H	H1	B	B1	B2	Ducts
Verso S 1300 F	893	925	350	152	700	350	–	∅250 (2×)
Verso S 2100 F	893	953	350	152	1000	500	–	700×200 (2×)
Verso S 3000 F	1160	1227	555	250	1015	507,5	357,5	600×400 (2×)

Mounting positions

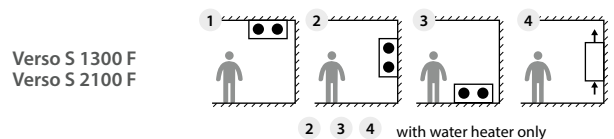

Verso S 3000 F

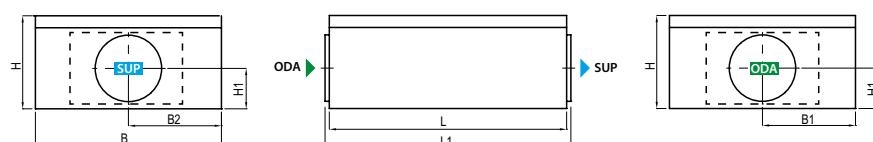
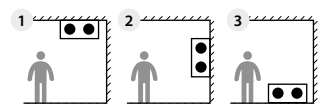

▶ ODA – outdoor intake ▶ SUP – supply air ▶ ETA – extract indoor ▶ EHA – exhaust air

Detailed technical characteristics of the units can be obtained with the VERSO selection software.

VERSO Pro VERSO Pro2



VERSO PRO

Modular air handling units for commercial ventilation. The air flow capacity: 1000–40 000 m³/h. VERSO Pro air handling units range has two types of durable casing: frameless (1000–22 000 m³/h) and reinforced frame design (7000–40 000 m³/h). Both of them are modular, thus custom and flexible configurations are possible. High-efficiency components of the VERSO Pro air handling units, ensure the best performance and energy saving. Consequently, the application areas are quite wide: from small offices to huge shopping malls or industrial buildings.

VERSO PRO2

Advanced and highly efficient modular air handling units. The air flow capacity: 1000–40 000 m³/h. VERSO Pro2 range uses the latest technologies to ensure the best energy-saving and operation parameters. The superior performance classes T2 / TB1 / L1 / D1 have been achieved thanks to the patented casing design for sizes from 12 to 72. The VERSO Pro2 series offers 1,6 million possible combinations for the simplest and the most complex projects, such as business centers, shopping malls, sports arenas, cinemas and theatres, hotels, airports, logistic centers, industry.



PATENTED PRO2 CASING – SUPERIOR PERFORMANCE

Advanced PVC profile technology ensures best casing characteristics: minimal energy losses, lowest sound levels, highest air tightness and mechanical durability.



Thermal bridging



Leakage

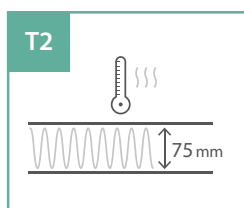

Thermal transmittance

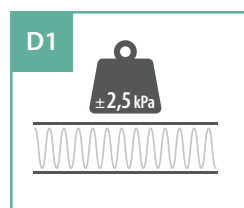

Mechanical strength

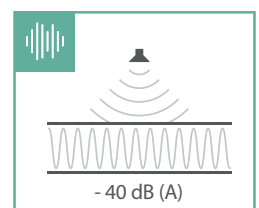

Casing sound insulation

VERSΟ Pro, VERSΟ Pro2 design

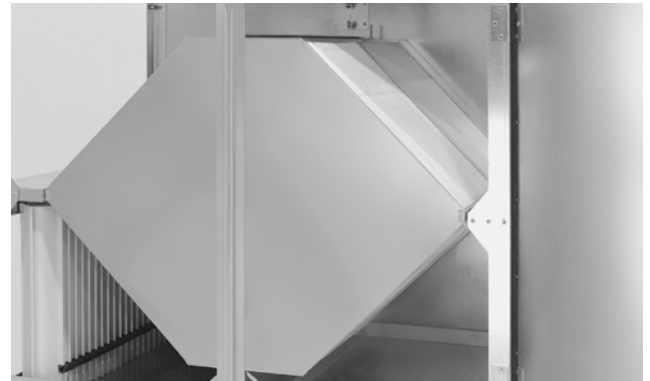
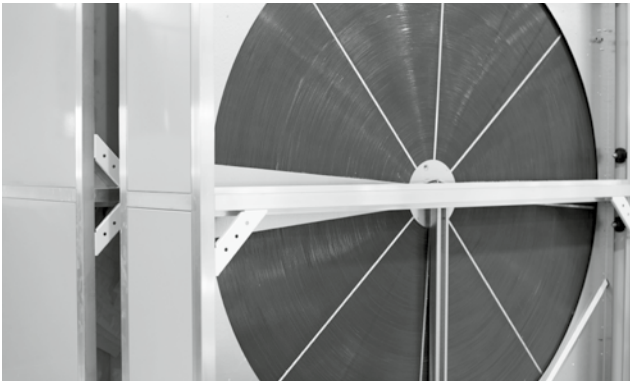

HEAT EXCHANGERS

Rotary heat exchanger

Used in Verso R series units. Temperature efficiency factor – up to 86%. Possible wave height: L, ML, SL.

Types of rotary heat exchangers:

- Condensing (aluminium);
- Condensing with epoxy coating;
- Sorption-enthalpy (aluminium with zeolite 3Å coating).

Rotary heat exchangers are made of seawater-resistant aluminum foil, the casing is also made of galvanized steel. Rotary heat exchanger rotation speed is controlled by a frequency converter, according to the air temperature. The heat exchanger can be ordered with an installed purge section.

Counter flow plate heat exchanger

Used in Verso CF series units. Temperature efficiency factor – up to 95% in wet conditions and up to 88% in dry conditions. The plate heat exchanger is equipped with an automatic by-pass. The heat exchanger is made of seawater-resistant aluminum plates. The distance between the plates is 2,1 or 3 mm.

VERSΟ Pro2 series units can be ordered with an diffusion-enthalpy counterflow plate heat exchanger.

HEAT EXCHANGER FROST PREVENTION

Under conditions when the outdoor air temperature is low and humidity is high, the risk of heat exchanger frosting may occur. Various types of frost prevention are used in VERSΟ Pro and Pro2 units:

- Counterflow plate exchangers have integrated pressure drop sensors, which detects accumulating ice and initiate defrosting algorithms when needed. As standard cold air by-pass damper is opened in case of frost, while warm extracted air heats up the exchanger. Optionally "Multi-level frost prevention (FP)" can be added when selecting an air handling unit with counterflow heat exchanger. The function is controlling segmented air damper, which performs partial defrosts, at the same time allowing 2/3 of heat exchanger still to be used for heat recovery, thus more thermal energy is saved, without a significant increase in heater power.
- Rotary heat exchangers usually do not freeze, however with high indoor humidity and extremely low outdoor temperatures snow crystals may start blocking the air flow. Thus exchanger efficiency fluctuations are preventively monitored and rotary wheel speed is slowed down to increase its surface temperature if efficiency is constantly decreasing in winter.
- Besides all mentioned measures, external preheater control is also available, for units that are intended to be used under harsh outdoor conditions.





FANS

In VERSO series units plug type fans are used, so, units are silent and use electricity effectively. The fans are balanced statically and dynamically, based on the ISO 1940 standard; therefore, unit vibration is minimal and meets all requirements.

When running, fans exhibit the following qualities:

- Very high efficiency coefficient.
- Frequency converters ensure an optimal capacity.
- Good acoustic performance.
- Longevity: a fan is directly connected to the electric motor, so, there is no a belt gear that simplifies maintenance.
- There is a possibility of installing an air flow measuring device.

Two types of fan motors are available – three-phase permanent magnet synchronous motors (PM) (400 V, 50 Hz), controlled by frequency converters, or electronically commutated (EC) with an integrated electronic controller with 20-100 % speed regulation. Safety category – IP54 according to IEC 34-5. Windings insulation category – F. Maximum operating temperature is 40°C.

Fan impellers

- The highest efficiency of the impeller with backward curved blades.
- Static efficiency up to 80%.
- Statically and dynamically balanced in accordance with the standard ISO1940.
- Material – composite, aluminium or painted steel.

Frequency converters

- High energy efficiency – 97%.
- Low heat dissipation.
- Specially designed algorithms for optimal PM motor control.

PM motors

- Highest energy efficiency – more than 93%.
- Ultra Premium IE5 efficiency class according to IEC.
- Compact dimensions and low weight.
- Wide range of regulation while maintaining high efficiency.
- Low heat dissipation.
- Reliability and durability.
- The shortest payback time.

Motor efficiency classes according to IEC*

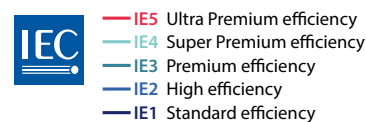
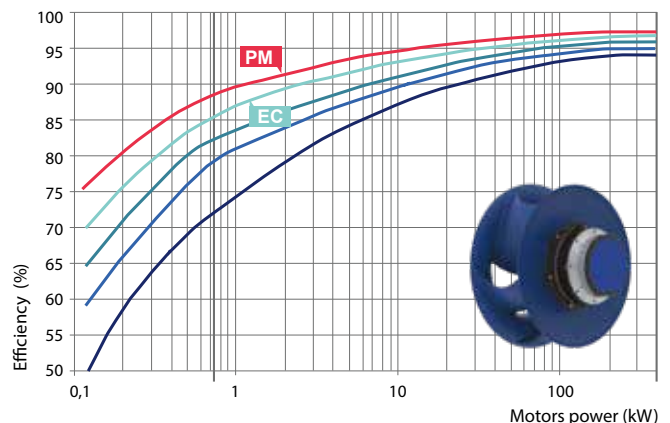

* International Electrotechnical Commission



AIR HEATERS

Water air heaters

Heaters are made of copper tubes and aluminum fins (spacing 2,2; 2,6; 3,0; 3,4 mm) in galvanized steel casing insulated with a mineral wool. As an option can be ordered with a threat joint to connect a freezing sensor. Capillary antifreeze sensor can also be ordered.

- Maximum operating pressure – 21 bars.
- Maximum water temperature +130°C.
- Heated air temperature – up to +40°C.

Electric air heaters

Stainless steel heating elements are used in air handling units. A three level protection ensures protection from overheating.

- Protection class IP54 in accordance with IEC 34-5.
- Heated air temperature – up to +40°C.

Note: The exact dimensions of the electric air heater and other data can be found in the VERSΟ air handling unit selection software. The electric heater has a separate power supply.

AIR COOLERS

Water air coolers

Air coolers are made of copper tubes and aluminum fins (spacing 2,2; 2,6; 3,0; 3,4 mm) in galvanized steel casing insulated with a mineral wool. Cooler section is assembled with stainless steel (AISI 304) sloping drain tray and a water trap.

Maximum operating pressure – 21 bars.

Direct evaporation air coolers

DX coolers are made of copper tubes and aluminum fins (spacing 2,2; 2,6; 3,0; 3,4 mm) in galvanized steel casing insulated with a mineral wool. Cooler section is assembled with stainless steel (AISI 304) sloping drain tray and a water trap.

Maximum operating pressure – 42 bars.

The power of the DX cooler can be divided into 2; 3 or 4 steps. DX coil also can operate in heating mode.



AIR DAMPERS

Closing air dampers installed in the air handling units are produced from aluminium with rubber sealing.

Duct connecting flanges – L20.

For unit sizes 60, 70, 80 – L30; for sizes 90; 100 – L40.

Dampers are located outside the unit; they can be made with an insulated damper casing. Standard tightness Class 2 damper actuator torque – 4 Nm/m². Higher tightness Class 3 dampers actuator torque – 15 Nm/m².

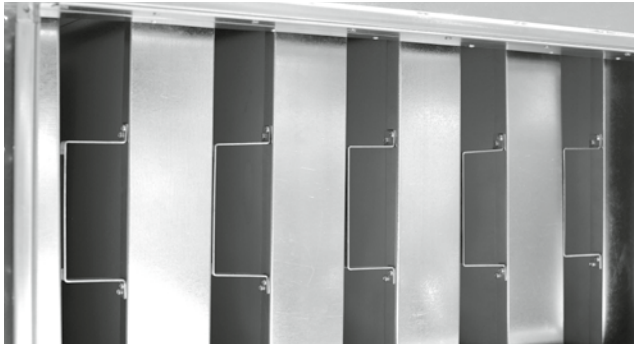

SILENCER SECTIONS

Integrated silencer sections can be ordered for VERSO air handling units, which will reduce the noise of the fans to the duct system.

The sound attenuation section of 900 mm length will reduce the noise to air ducts by 15 to 20 dB, a longer section of 1200 mm in length – by 20 to 25 dB. The width and height of these sections correspond to air-handling unit dimensions.

Sound attenuating splitters with resonating panels is mounted inside the section. Splitters are filled with special acoustic mineral stone wool and are covered by non-woven glass fiber felt certified to be inside the air duct. Mineral wool can be replaced with polyester wool in the case of a special request.

Splitters of the absorber can be easily removed from the section for dry or semi-wet washing for ventilation hygiene purposes.



AIR FILTERS

From G4 to F9 class synthetic bag filters are used. Also G4 or M5 panel type prefilter can be selected on supply air flow.

The filter clamping mechanism ensures tightness and simplifies the filter replacement procedure.

Internal pressure sensors monitor filter pressure drop in real-time and display filter impurity percentage on the user interface. KOMFOVENT air filters correspondence to ISO 1890 standard:

Bag filters ISO 16890	Filter class EN 779:2012	Filter depth, mm
Coarse 65%	G4	360
ePM10 60%	M5	500; 635
ePM10 65%	M6	500; 635
ePM1 60%	F7	500; 635
ePM1 85%	F9	500; 635



INSPECTION WINDOW AND LIGHTING

Inspection windows and internal lightning enable you to observe the unit's operation and help to perform the maintenance in a poorly lit environment.

The diameter of the plastic window is 200 mm.



CASING CORROSION PROTECTION

Standard casing anti-corrosion protection class – C3. Higher anti-corrosion protection class C4 is also available.



OUTDOOR HOODS

Outdoor hoods can be additionally mounted on the supply and exhaust air dampers, to protect damper actuators, and to cover inlet/outlet openings when units are installed outside.



ROOF

When the outdoor air handling unit is selected it will be equipped with a specially designed roof to protect it from weather conditions.



DOOR LOCKS AND HANDLES

Easy to use door locks and handles ensure safe unit maintenance.

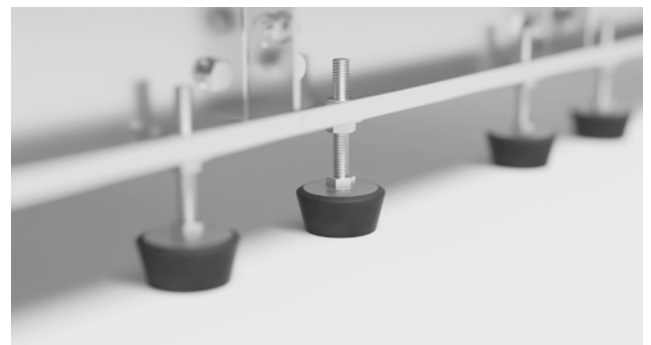

HEIGHT-ADJUSTABLE FEET

The construction frame of the air handling unit with height adjustable feet makes it much easier to level the unit on the site.

Sizes and capacities of VERSO Pro, Pro2 units

VERSO R PRO

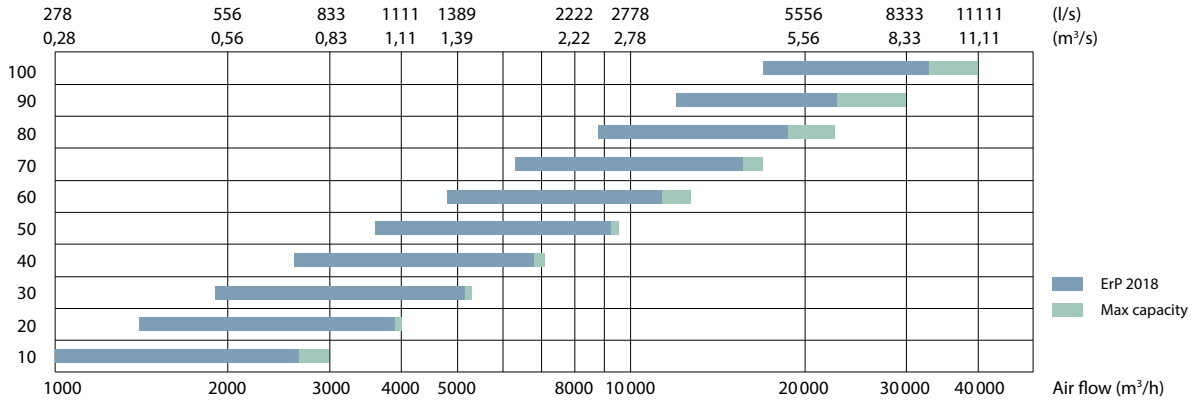

Size	B	H	L ^{1.1}	L ^{1.2}	L ^{1.3}	L ^{1.4}	b	h	A
10	1000	1000	618	370	435	800	700	300	150
20	1150	1150	751	370	435	800	900	400	150
30	1300	1300	751	370	435	800	1000	500	150
40	1500	1520	751	390	435	800	1200	600	150
50	1700	1715	885	390	435	800	1400	700	150
60	1900	1920	885	390	570	800	1600	800	150
70	2100	2100	885	390	705	800	1800	900	150
80	2300	2420	1250	510	841	830	2000	1000	125
90	2610	2650	1400	550	1040	830	2200	1100	125
100	3770	2420	1250	1400	841	830	3400	1000	125

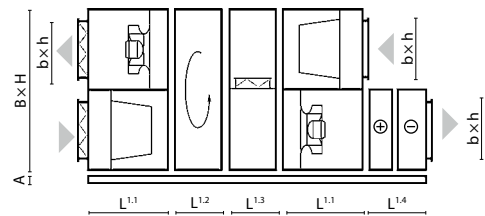

Note: the electric air heaters, water heaters and coolers section length and configuration are noted in the selection programme of VERSO air handling units.

VERSO R PRO2

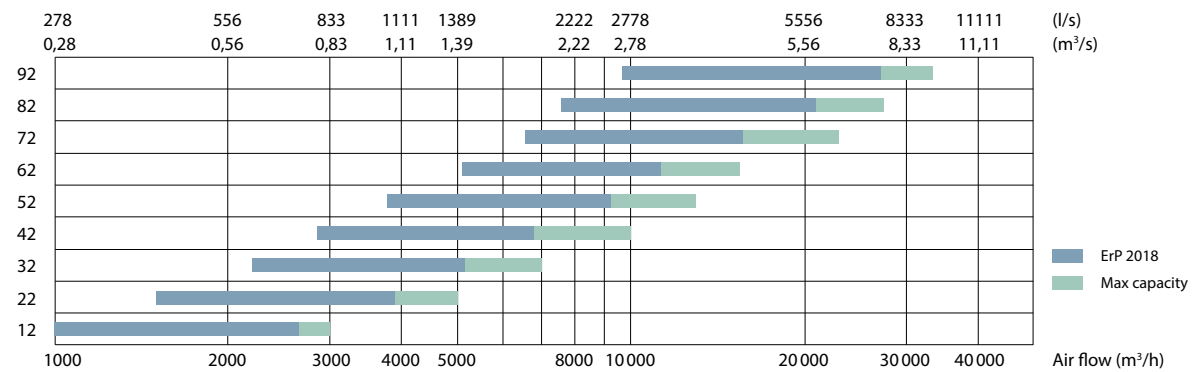

Size	B	H	L ^{1.1}	L ^{1.2}	L ^{1.3}	L ^{1.4}	b	h	A
12	1054	1054	751	380	515	865	700	300	150
22	1204	1204	751	380	515	865	900	400	150
32	1354	1354	751	380	515	865	1000	500	150
42	1554	1574	751	380	515	865	1200	600	150
52	1754	1769	885	380	515	865	1400	600	150
62	1954	1974	885	380	640	865	1600	700	150
72	2154	2154	885	380	765	865	1800	800	150
82	2360	2440	1250	500	825	1060	2000	1000	125
92	2660	2660	1400	500	1020	1060	2300	1100	125

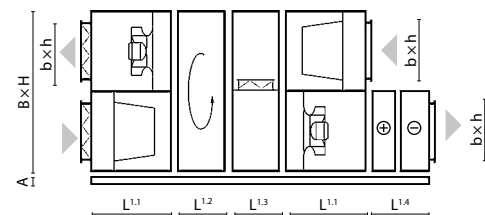

Note: the electric air heaters, water heaters and coolers section length and configuration are noted in the selection programme of VERSO air handling units.

VERSO CF PRO

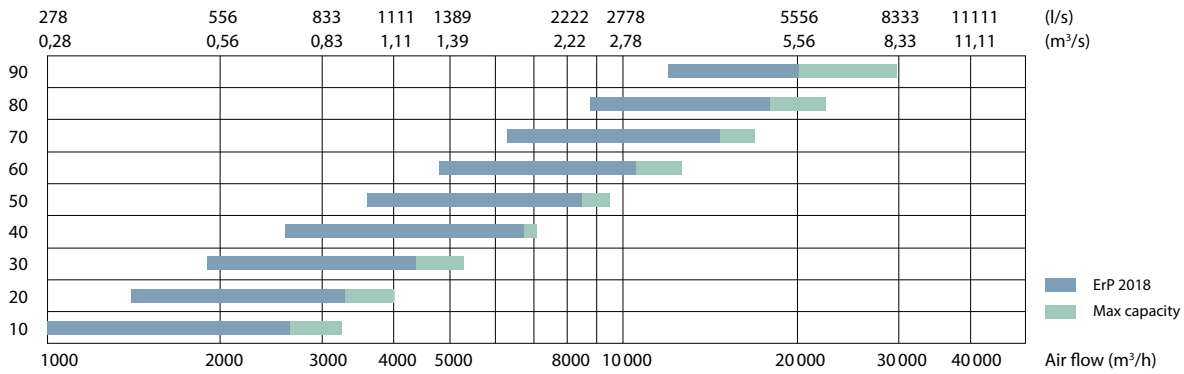

Size	B	H	L ^{1.1}	L ^{1.2}	L ^{1.3}	b	h	A
10	1000	1000	618	570	435	700	300	150
20	1150	1150	751	645	435	900	400	150
30	1300	1300	751	720	435	1000	500	150
40	1500	1520	751	720	435	1200	600	150
50	1700	1715	885	720	435	1400	700	150
60	1900	1920	885	930	570	1600	800	150
70	2100	2100	885	1020	705	1800	900	150
80	2300	2420	1250	1250	841	2000	1000	125
90	2610	2650	1400	1250	1040	2200	1100	125

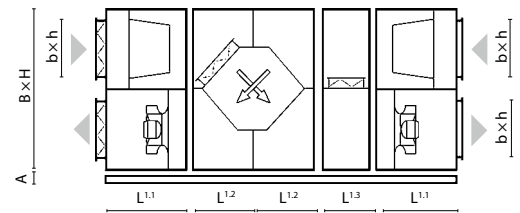

Note: size 20÷70 plate heat exchanger section is made of two parts. Size 10, 80 and 90 – of one part. The electric air heater section length is noted in the selection programme of VERSO air handling units.

VERSO CF PRO2

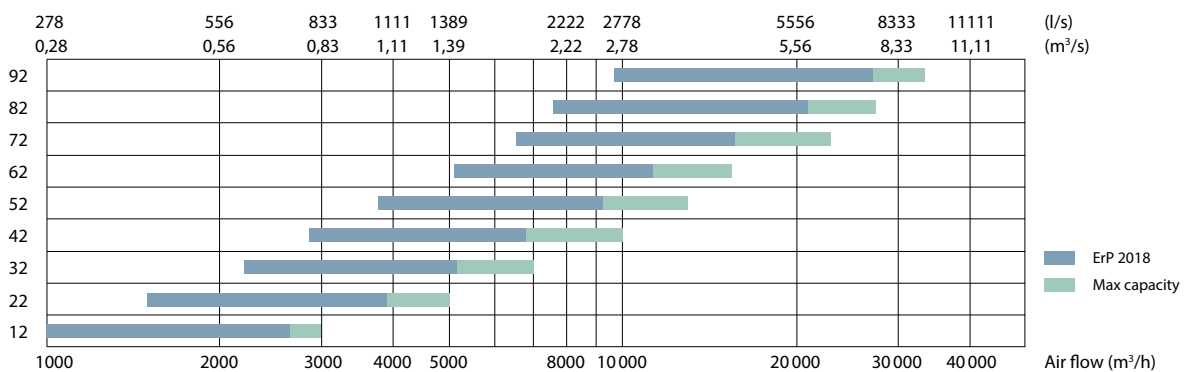

Size	B	H	L ^{1.1}	L ^{1.2}	L ^{1.3}	b	h	A
12	1054	1204	751	1428	515	700	300	150
22	1204	1354	751	1548	515	900	400	150
32	1354	1574	751	1648	515	1000	500	150
42	1554	1769	751	1934	515	1200	600	150
52	1754	1974	885	2102	515	1400	600	150
62	1954	2154	885	2102	640	1600	700	150
72	2154	2154	885	2102	765	1800	800	150
82	2360	2440	1250	2770	825	2000	1000	125
92	2660	2660	1400	2770	1020	2300	1100	125

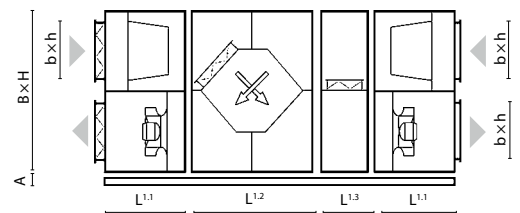

Note: if data do not correspond to data in the selection software, please refer to data shown in software.

VERSO S PRO

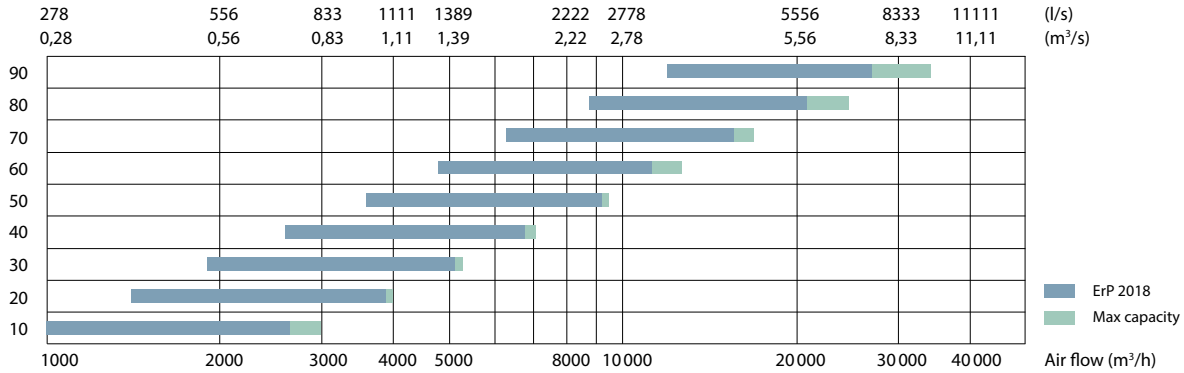

Size	B	H	L ^{1.1}	L ^{1.2}	L ^{1.4}	b	h	b1	h1	b2	h2	A
10	1000	490	750	705	430	900	400	700	300	700	300	150
20	1150	585	750	705	430	1100	500	900	400	1000	300	150
30	1300	660	750	705	470	1200	600	1000	500	1100	400	150
40	1500	740	750	842	470	1400	700	1200	600	1200	400	150
50	1700	890	750	842	470	1600	800	1400	700	1400	400	150
60	1900	960	750	979	570	1800	900	1600	800	1600	500	150
70	2100	1085	750	979	705	2000	1000	1800	900	1800	600	150
80	2300	1235	750	1250	705	2200	1100	2000	1000	2000	600	125
90	2610	1350	750	1400	705	2500	1200	2200	1100	2200	600	125

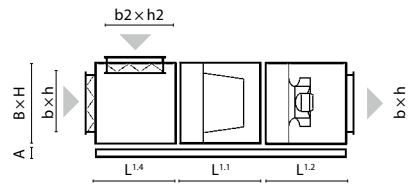

Note: the electric air heaters, water heaters and coolers section length and configuration are noted in the selection programme of VERSO air handling units.

VERSO S PRO2

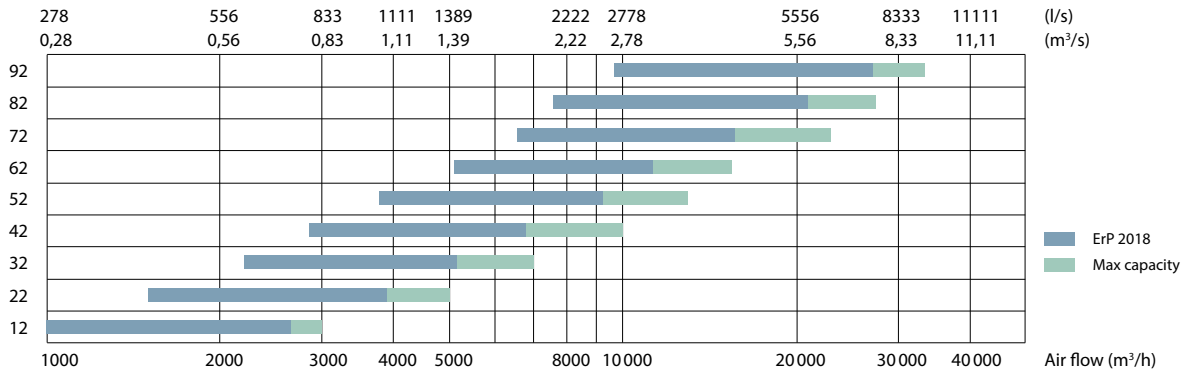

Size	B	H	L ^{1.1}	L ^{1.2}	b	h	A
12	1054	540	650	1000	700	300	150
22	1204	635	650	1000	900	400	150
32	1354	710	650	1000	1000	500	150
42	1554	790	650	1000	1200	600	150
52	1754	940	650	1000	1400	600	150
62	1954	1040	650	1000	1600	700	150
72	2154	1125	650	1000	1800	800	150
82	2360	1200	705	1250	2000	1000	125
92	2660	1400	705	1400	2300	1100	125

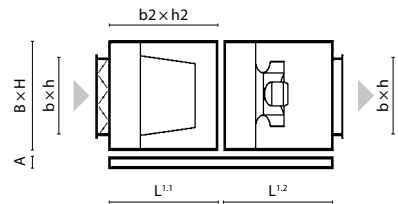

Note: the electric air heaters, water heaters and coolers section length and configuration are noted in the selection programme of VERSO air handling units.

VERSO RA PRO2

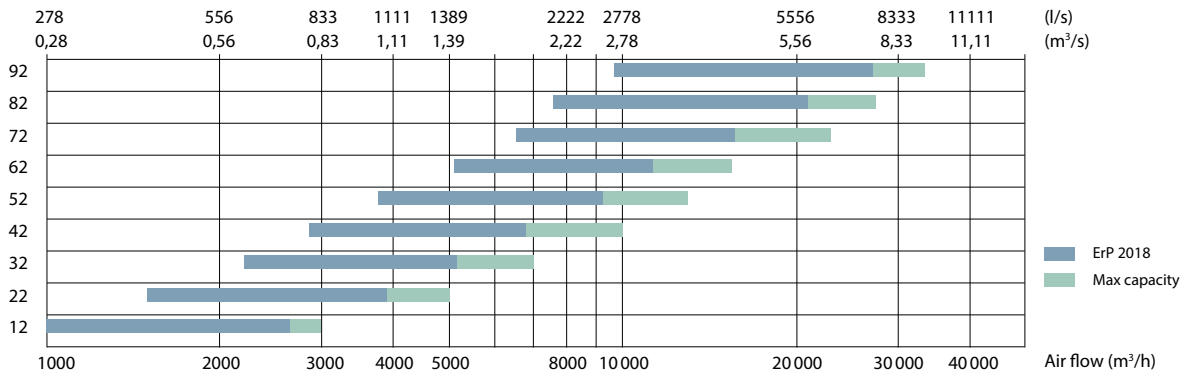

Size	B	H	L ^{1.1}	L ^{1.2}	L ^{1.3}	L ^{1.4}	b	h	A
12	1054	540	650	1000	840	950	700	300	150
22	1204	635	650	1000	840	950	900	400	150
32	1354	710	650	1000	840	950	1000	500	150
42	1554	790	650	1000	840	950	1200	600	150
52	1754	940	650	1000	840	950	1400	600	150
62	1954	1040	650	1000	840	950	1600	700	150
72	2154	1125	650	1000	840	950	1800	800	150
82	2360	1200	705	1250	830	1060	2000	1000	125
92	2660	1400	705	1400	830	1060	2300	1100	125

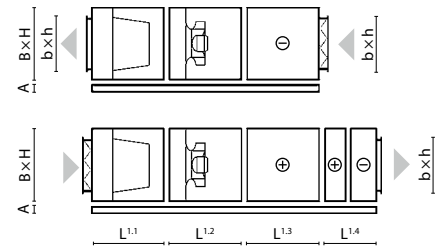

Note: the electric air heaters, water heaters and coolers section length and configuration are noted in the selection programme of VERSO air handling units.



RHP

Complete Indoor
Climate Control



The range of innovative air handling units with integrated heat pumps, covering all indoor climate support systems

Comfortable indoor climate in one unit



Two-stage heat / cool recovery

To reach the maximum efficiency Komfovent RHP units are designed to recover the energy in two steps:

1st step | **recovery up to 80%**
by sorption-enthalpy rotary heat exchanger

2nd step | **recovery up to 60%**
by reversible heat pump

Wide possibilities with RHP:

- Unit monitoring and management through the Internet and BMS.
- Extremely high energy efficiency.
- Simple designing, installing, operation and maintenance.
- Shortest payback time.
- Unified smart control, simplified management.
- No outdoor unit, no refrigeration specialists required.

Operation range:



Integrated control system C5

Automatic system designed for professionals, controls thermodynamic processes and saves energy. The user is given detailed information about the operation of the unit. Variety of modes and functions allows the user to choose the optimal operating mode that maximizes energy saving.

RHP Standard



Why choose RHP Standard units?

Total comfort all year long

Reversible heating and cooling operation of heat pump ensures comfort indoor climate.

Added value to indoor climate

Heating and humidity recovery in winter, cooling and dehumidifying in summer.

"All-inclusive" solution

No need for condensing unit, chiller, piping or additional work providing.

Convenience and safety

Factory-charged with refrigerant; no refrigeration knowledge is needed.

Energy-efficient and resource saving

Two-step efficiency is provided by rotary heat exchanger recovery and post heating / cooling operated by a heat pump.

Compact design

It saves building spaces, easier transportation.

Precise temperature regulation

Precise maintenance of the set temperature EXV (electronic expansion valve) ensures precise regulation of the desired supply air temperature.

Eco-friendly and protected

Non ozone depleting refrigerant R134A is used in RHP units and one circuit charge limits are applied.

Factory tested

Reliable and convenient "Plug and Play" installation, commissioning and exploitation.

Intelligent control

Clever automatic control algorithms and reliable components ensure safe and efficient equipment operation.

Exclusive connectivity – 16 ways *

Allows optimal and rational connection of the ducts. Universal design – 16 duct connections options are explained on p. 58.

* Except model RHP 400 V.



Sizes and capacities of RHP Standard units

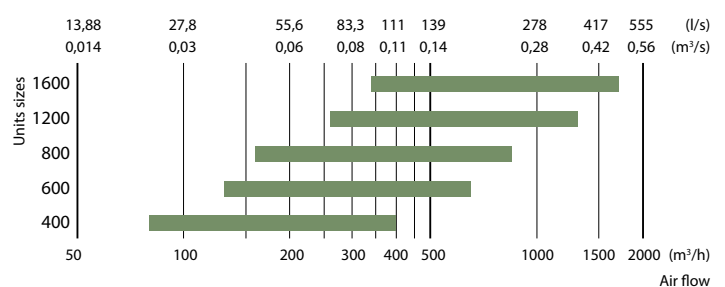

RHP 400 V C5

Nominal air flow, m ³ /h	392
Nominal air flow, l/s	109
Electric air heater capacity, kW / Δt, °C	1 / 7,5
Supply voltage, V	1~230
Maximal operating current, A	7,6
Power supply cable, mm ²	3×1,5
Electric power input of the fan drive at maximum flow rate, W	103
Noise power level, L _{WA} , dB(A)	54
Noise pressure level, L _{PA} , dB(A) (3 m)	43
Filters dimensions B×H×L, mm	462×200×46
Unit dimensions B×H×L, mm	618×1015×712
Panel thickness, mm	30/50
Maintenance space, mm	720
Refrigerant R134 A, kg	1,1
Unit weight, kg	106



Performance

Unit with standard equipment

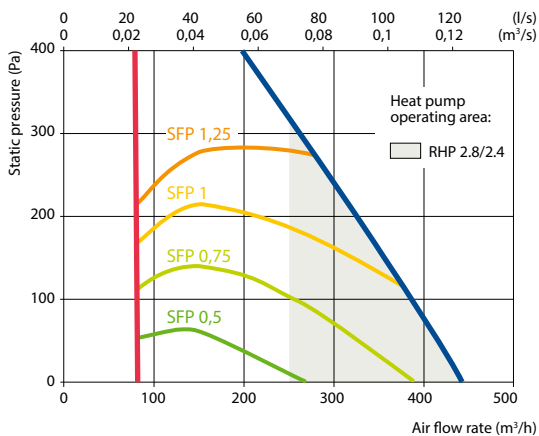

Temperature efficiency

Outside temperature, °C	Winter					Summer		
	-23	-15	-10	-5	0	25	30	35
After heat exchanger, °C	8,9	11,2	12,7	14,1	15,6	22,9	24,3	25,8

Indoor +22°C, 20 % RH

Shown as right (R1)

The unit is available only right inspection side.

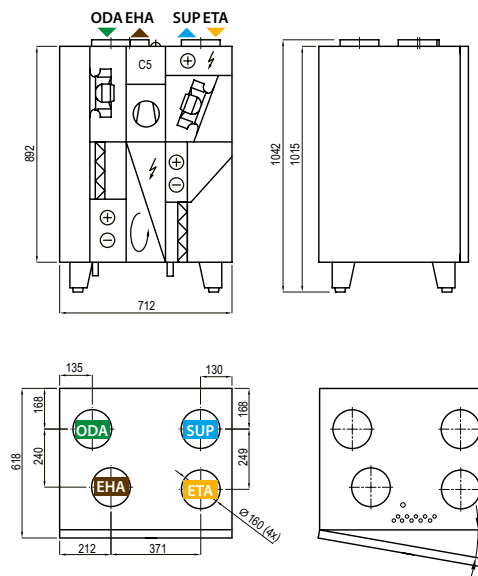

▶ ODA – outdoor intake ▶ SUP – supply air ▶ ETA – extract indoor ▶ EHA – exhaust air

Accessories

Closing damper	AGUJ-M-160+LF24/CM24
Silencer	ODA/EHA AGS-160-50-600-M
	SUP/ETA AGS-160-50-900-M

Heating mode

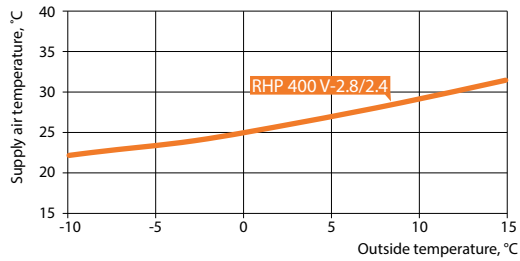

Cooling mode

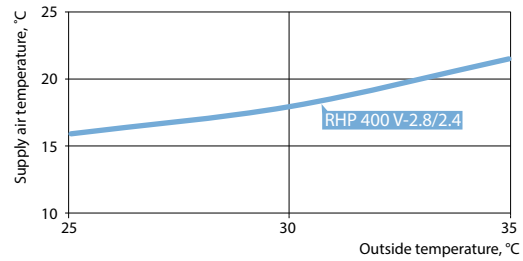

Heat pump parameters

	RHP 400 V-2.8/2.4					
	Heating			Cooling		
Outdoor temperature, °C	7	2	-7	35	27	
Outdoor air related humidity, %	86	84	74	40	45	
Indoor air temperature, °C	20	20	20	27	21	
Indoor air related humidity, %	50	50	45	40	50	
Supply air temperature, °C	28,6	26	21,8	20,6	14,5	
Heat pump heating/cooling power, kW	1,58	1,46	1,27	1,63	1,5	
Heat pump heating/cooling power consumption, kW	0,45	0,42	0,35	0,51	0,42	
System SCOP ^{1,2,3} , Average climate / System SEER ^{1,2,3}		7,2			3,45	
COP/EER	3,48	3,44	3,68	3,22	3,54	

¹ Rotary heat exchanger wave size "L"

² Rotary heat exchanger + heat pump

³ According to EN 14825 standard

RHP 600 U C5

Nominal air flow, m ³ /h	668
Nominal air flow, l/s	186
Electric air heater capacity, kW / Δt, °C	1 / 4,4
Supply voltage, V	1~230
Maximal operating current, A	9,6 (RHP 3.7/3)
Maximal operating current, A	10,5 (RHP 4.4/3.8)
Power supply cable, mm ²	3×1,5
Electric power input of the fan drive at maximum flow rate, W	150
Noise power level, L _{WA} , dB(A)	53
Noise pressure level, L _{PM} , dB(A) (3 m)	42
Filters dimensions B×H×L, mm	500×280×46
Unit dimensions B×H×L, mm	650×894×1254
Panel thickness, mm	50
Maintenance space, mm	600
Refrigerant R134 A, kg	2,08
Unit weight, kg	194



Performance

Unit with standard equipment

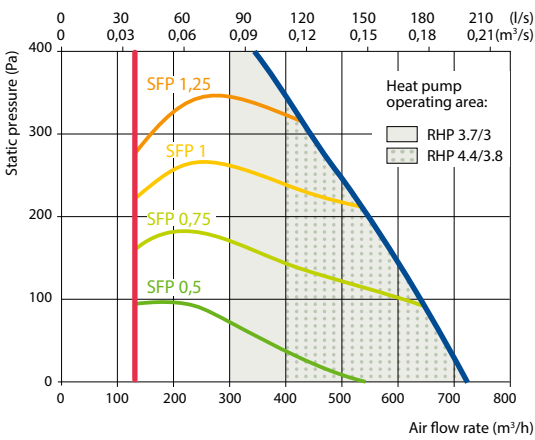

Accessories

Closing damper	AGUJ-M-200+LF24/CM24
Silencer	ODA/EHA AGS-200-50-600-M SUP/ETA AGS-200-50-900-M

Temperature efficiency

	Winter					Summer		
Outside temperature, °C	-23	-15	-10	-5	0	25	30	35
After heat exchanger, °C	12,5	14,2	15,2	16,3	17,3	22,6	23,7	24,8

Indoor +22°C, 20 % RH

Shown as right (R1)

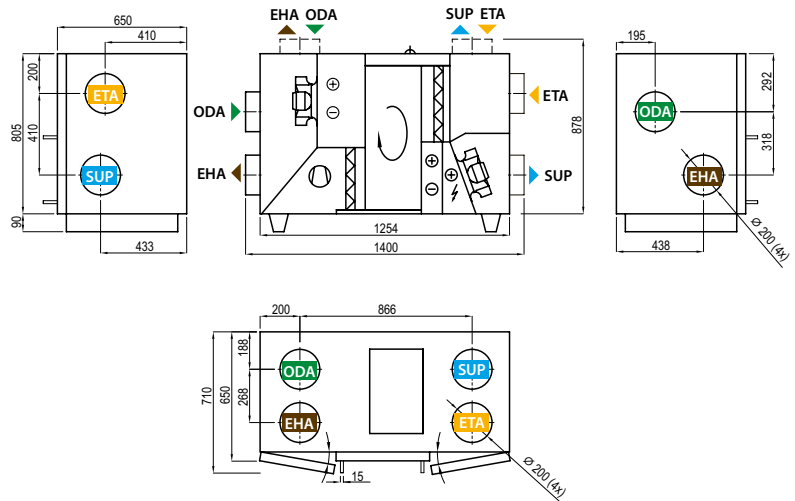

Shown as left (L1)

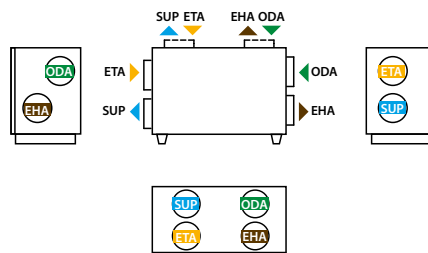

▶ ODA – outdoor intake ▶ SUP – supply air ▶ ETA – extract indoor ▶ EHA – exhaust air

Heating mode

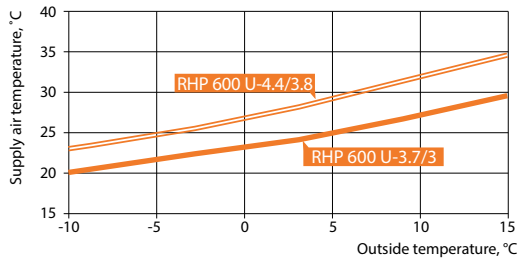

Cooling mode

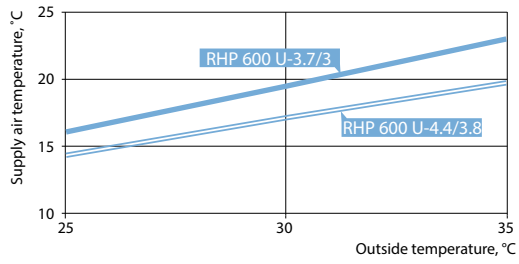

Heat pump parameters

	RHP 600 U-3.7/3					RHP 600 U-4.4/3.8				
	Heating			Cooling		Heating			Cooling	
Outdoor temperature, °C	7	2	-7	35	27	7	2	-7	35	27
Outdoor air related humidity, %	86	84	74	40	45	86	84	74	40	45
Indoor air temperature, °C	20	20	20	27	21	20	20	20	27	21
Indoor air related humidity, %	50	50	45	40	50	50	50	45	40	50
Supply air temperature, °C	25	23,2	20	20,6	14,8	27,9	25,9	22,2	18,8	13,2
Heat pump heating/cooling power, kW	1,67	1,51	1,24	1,8	1,68	2,34	2,21	1,74	2,37	2,92
Heat pump heating/cooling power consumption, kW	0,4	0,38	0,34	0,43	0,38	0,62	0,53	0,52	0,68	0,63
System SCOP ^{1,2,3} , Average climate / System SEER ^{1,2,3}	13,3			4,52		9,7			4,7	
COP/EER	4,21	4	3,62	4,19	4,46	3,77	4,18	3,33	3,49	4,62

¹ Rotary heat exchanger wave size "L"
² Rotary heat exchanger + heat pump
³ According to EN 14825 standard

RHP 800 U C5

Nominal air flow, m ³ /h	860
Nominal air flow, l/s	239
Electric air heater capacity, kW / Δt, °C	2 / 6,8
Supply voltage, V	3~400
Maximal operating current, A	8,6 (RHP 5.3/4.7)
Maximal operating current, A	8,6 (RHP 6.1/5.8)
Power supply cable, mm ²	5x1,5
Electric power input of the fan drive at maximum flow rate, W	155
Noise power level, L _{WA} , dB(A)	53
Noise pressure level, L _{PM} , dB(A) (3 m)	42
Filters dimensions BxHxL, mm	750x400x46
Unit dimensions BxHxL, mm	910x986x1505
Panel thickness, mm	50
Maintenance space, mm	800
Refrigerant R134 A, kg	3,1
Unit weight, kg	255



Performance

Unit with standard equipment

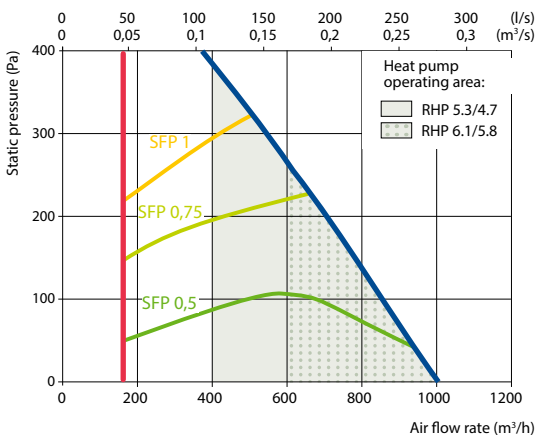

Temperature efficiency

	Winter					Summer		
Outside temperature, °C	-23	-15	-10	-5	0	25	30	35
After heat exchanger, °C	14,2	15,6	16,5	17,3	18,2	22,5	23,4	24,2

Indoor +22°C, 20 % RH

Shown as right (R1)

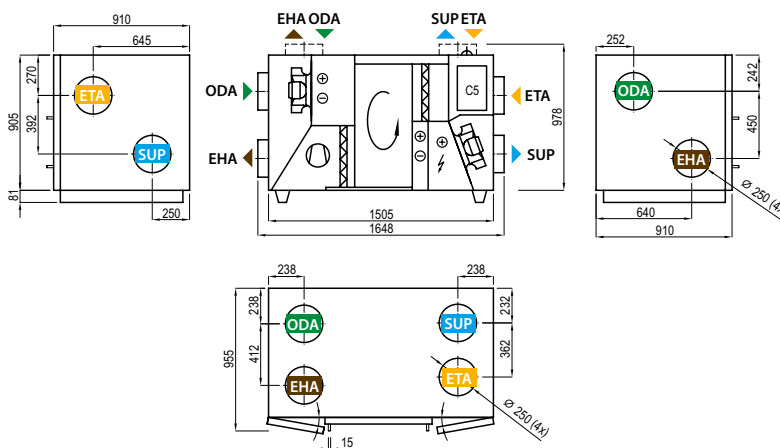

Shown as left (L1)

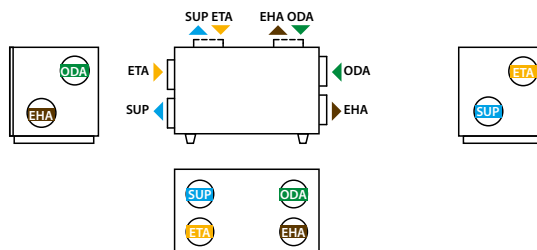

▶ ODA – outdoor intake ▶ SUP – supply air ▶ ETA – extract indoor ▶ EHA – exhaust air

Accessories

Closing damper	AGUJ-M-250+LF24/CM24
Silencer	ODA/EHA AGS-250-50-600-M SUP/ETA AGS-250-50-900-M

Heating mode

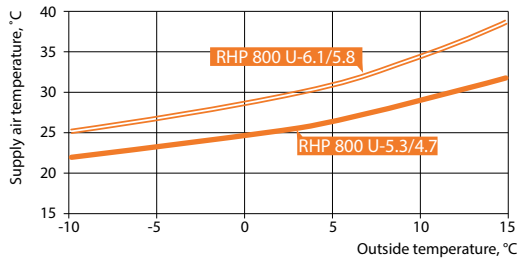

Application: 20 °C, RH 45% indoor.

Cooling mode

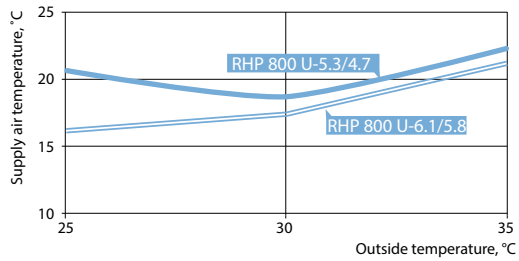

Application: 24 °C, RH 55% indoor.
Total (heating and cooling) – rotary heat recovery + heat pump.

Heat pump parameters

	RHP 800 U-5.3/4.7					RHP 800 U-6.1/5.8				
	Heating			Cooling		Heating			Cooling	
Outdoor temperature, °C	7	2	-7	35	27	7	2	-7	35	27
Outdoor air related humidity, %	86	84	74	40	45	86	84	74	40	45
Indoor air temperature, °C	20	20	20	27	21	20	20	20	27	21
Indoor air related humidity, %	50	50	45	40	50	50	50	45	40	50
Supply air temperature, °C	26,7	25	21,6	19,1	13,3	29,6	27,5	24	17,1	11,8
Heat pump heating/cooling power, kW	2,51	2,35	1,77	2,73	2,55	3,48	3,11	2,47	3,33	3,27
Heat pump heating/cooling power consumption, kW	0,54	0,46	0,47	0,65	0,55	0,75	0,7	0,7	0,98	0,84
System SCOP ^{1,2,3} , Average climate / System SEER ^{1,2,3}	12,82			4,76		9,54			4,71	
COP/EER	4,69	5,1	3,77	4,22	4,68	4,65	4,41	3,51	3,41	3,89

¹ Rotary heat exchanger wave size "L"
² Rotary heat exchanger + heat pump
³ According to EN 14825 standard

RHP 1200 U C5

Nominal air flow, m ³ /h	1300
Nominal air flow, l/s	361
Electric air heater capacity, kW / Δt, °C	2 / 4,5
Supply voltage, V	3~400
Maximal operating current, A	8,8
Power supply cable, mm ²	5×1,5
Electric power input of the fan drive at maximum flow rate, W	288
Noise power level, L _{WA} , dB(A)	55
Noise pressure level, L _{PA} , dB(A) (3 m)	45
Filters dimensions B×H×L, mm	805×400×46
Unit dimensions B×H×L, mm	905×905×1505
Panel thickness, mm	45
Maintenance space, mm	800
Refrigerant R134 A, kg	3,4
Unit weight, kg	270



Performance

Unit with standard equipment

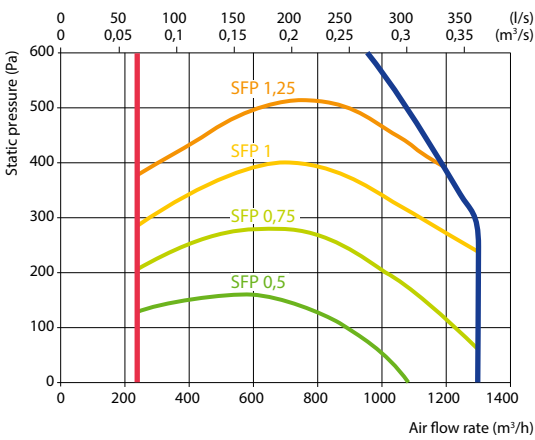

Temperature efficiency

	Winter					Summer		
Outside temperature, °C	-23	-15	-10	-5	0	25	30	35
After heat exchanger, °C	13,5	15,0	15,9	16,9	17,8	22,6	23,5	24,5

Indoor +22°C, 20 % RH

Shown as right (R1)

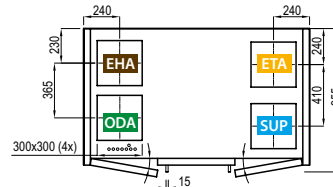
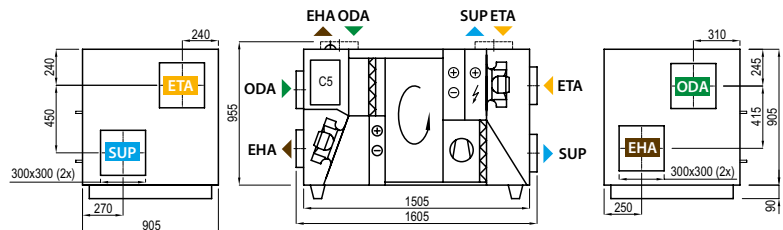

Shown as left (L1)

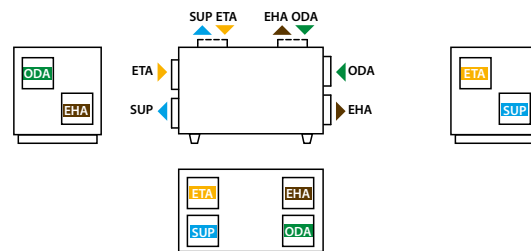

▶ ODA – outdoor intake ▶ SUP – supply air ▶ ETA – extract indoor ▶ EHA – exhaust air

Accessories

Closing damper	SRU-M-300x300+LF24/CM24
Silencer	ODA/EHA AGS-315-100-900-M SUP/ETA AGS-315-100-1200-M

Heating mode

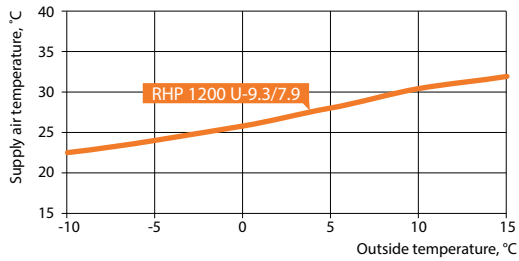

Application: 20°C, RH 45% indoor.

Cooling mode

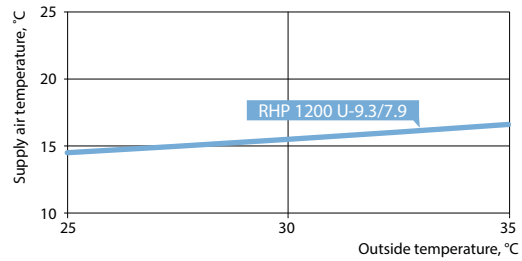

Application: 24°C, RH 55% indoor
Total (heating and cooling) – rotary heat recovery + heat pump.

Heat pump parameters

	RHP 1200 U 9.3/7.9				
	Heating			Cooling	
Outdoor temperature, °C	7	2	-7	35	27
Outdoor air related humidity, %	86	84	74	40	45
Indoor air temperature, °C	20	20	20	27	21
Indoor air related humidity, %	50	50	45	40	50
Supply air temperature, °C	29,1	27,0	23,9	17,1	12,2
Heat pump heating/cooling power, kW	5,11	4,61	3,92	5,31	5,11
Heat pump heating/cooling power consumption, kW	0,97	0,89	0,82	1,51	1,24
System SCOP ^{1,2,3} , Average climate / System SEER ^{1,2,3}	10,45			4,08	
COP/EER	5,27	5,17	4,75	3,51	4,13

¹ Rotary heat exchanger wave size "L"
² Rotary heat exchanger + heat pump
³ According to EN 14825 standard

RHP 1600 U C5

Nominal air flow, m ³ /h	1700
Nominal air flow, l/s	472
Electric air heater capacity, kW / Δt, °C	2 / 3,4
Supply voltage, V	3~400
Maximal operating current, A	8,8
Power supply cable, mm ²	5×1,5
Electric power input of the fan drive at maximum flow rate, W	363
Noise power level, L _{WA} , dB(A)	55
Noise pressure level, L _{PA} , dB(A) (3 m)	45
Filters dimensions B×H×L, mm	805×400×46
Unit dimensions B×H×L, mm	905×905×1505
Panel thickness, mm	45
Maintenance space, mm	800
Refrigerant R134 A, kg	3,4
Unit weight, kg	270



Performance

Unit with standard equipment

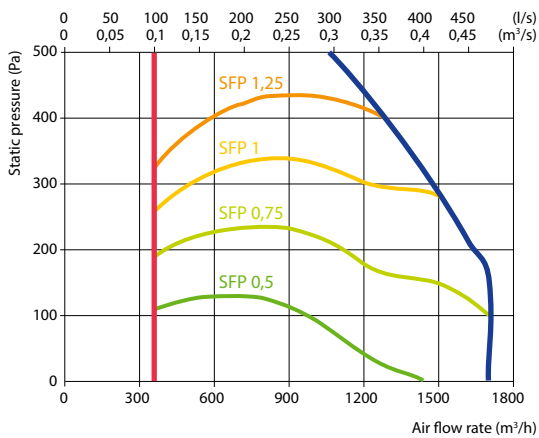

Temperature efficiency

	Winter					Summer		
Outside temperature, °C	-23	-15	-10	-5	0	25	30	35
After heat exchanger, °C	12,4	14,1	15,1	16,2	17,3	22,6	23,7	24,8

Indoor +22°C, 20 % RH

Shown as right (R1)

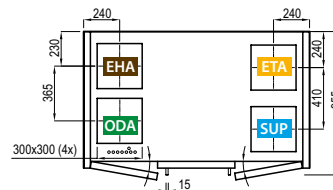
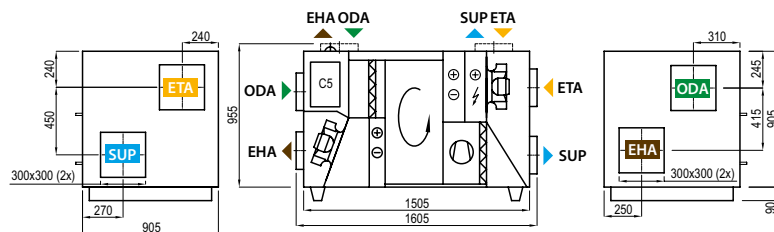

Shown as left (L1)

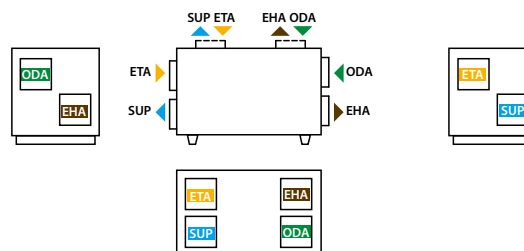

▶ ODA – outdoor intake ▶ SUP – supply air ▶ ETA – extract indoor ▶ EHA – exhaust air

Accessories

Closing damper	SRU-M-300x300+LF24/CM24
Silencer	ODA/EHA AGS-315-100-900-M SUP/ETA AGS-315-100-1200-M

Heating mode

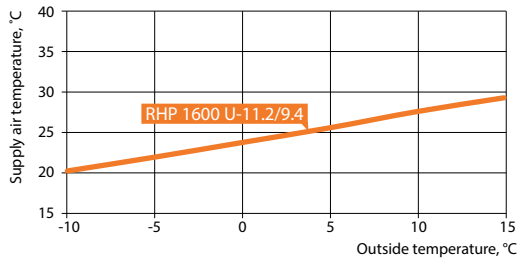

Application: 20°C, RH 45% indoor.

Cooling mode

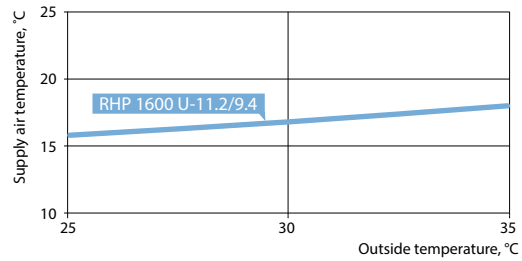

Application: 24°C, RH 55% indoor
Total (heating and cooling) – rotary heat recovery + heat pump.

Heat pump parameters

	RHP 1600 U 11.2/9.4				
	Heating			Cooling	
Outdoor temperature, °C	7	2	-7	35	27
Outdoor air related humidity, %	86	84	74	40	45
Indoor air temperature, °C	20	20	20	27	21
Indoor air related humidity, %	50	50	45	40	50
Supply air temperature, °C	26,3	24,4	21,1	18,9	13,6
Heat pump heating/cooling power, kW	5,26	4,79	3,99	5,73	5,42
Heat pump heating/cooling power consumption, kW	0,88	0,83	0,73	1,42	1,14
System SCOP ^{1,2,3} , Average climate / System SEER ^{1,2,3}	11,9			4,1	
COP/EER	5,95	5,79	5,5	4,04	4,74

¹ Rotary heat exchanger wave size "L"
² Rotary heat exchanger + heat pump
³ According to EN 14825 standard

RHP Pro RHP Pro2



Advantages of RHP Pro / Pro2 units

"Plug and Play" solution

Factory-charged with refrigerant and fully tested on cooling/heating modes before shipping. No need for a refrigeration specialist for installation and commissioning works.

Inverter compressors

Energy-efficient and silent inverter compressors enable accurate regulation and maintenance of supply air temperature.

Electronic expansion valve

For power adjustment of the integrated heat pump use an electronic EXV (electronic expansion valve), which ensures a stable supply air temperature and allows a wide range of regulation of device performance and heating/cooling capacity.

Sorption-enthalpy rotary heat exchanger

In RHP units sorption-enthalpy rotary regenerators with special 3Å zeolite coating are used, because of their hygroscopic selective features ensure good heat and humidity exchange, so the RHP units maintain an optimum indoor climate with minimal energy consumption.

Air filters



All units are equipped with a large surface area air filters with low pressure loss, it saves energy, replacement can be less often.

PM/EC fan motors

In RHP PRO units PM (permanent magnet) and EC (electronically commutated) fan motors are used, the most efficient on the market, conforming Ultra Premium IE5 or Super Premium IE4 efficiency class.

Patented Pro2 casing – superior performance

Advanced PVC profile technology ensures best casing characteristics: minimal energy losses, lowest sound levels, highest air tightness and mechanical durability.

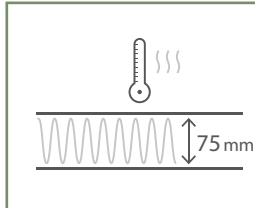
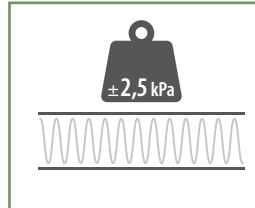
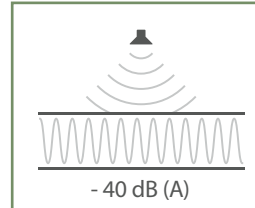
TB1 Thermal bridging	L1 Leakage	T2 Thermal transmittance	D1 Mechanical strength	 Casing sound insulation
				

RHP Pro

for larger area premises and required air flows from 500 m³/h to 25 000 m³/h

Air flow

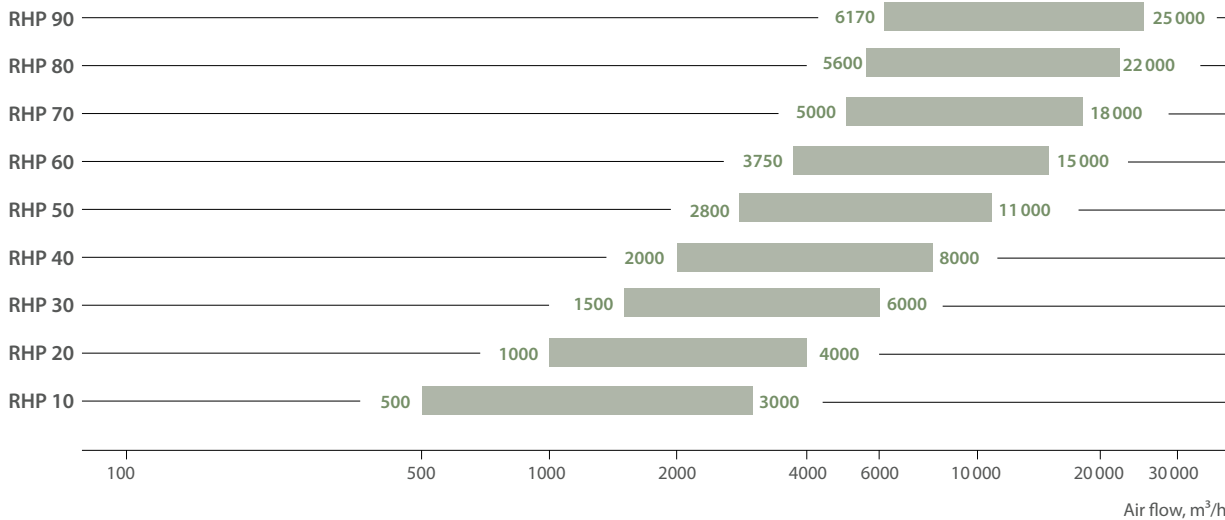

Outdoor Indoor	Size	RHP 10	RHP 20	RHP 30	RHP 40	RHP 50	RHP 60	RHP 70	RHP 80	RHP 90
Conditions according to EN 14511	Max air flow, m ³ /h	3000	4000	6000	8000	11000	15000	18000	22000	25000
	Min air flow, m ³ /h	500	1000	1500	2000	2800	3750	5000	5600	6170

Heating mode*

T, °C	-7	20	Total heating capacity, kW	34	48	68	96	123	161	197	234	277
RH, %	90	40	Supply temperature, °C	24	24	24	24	24	24	24	24	24
			Nominal compressor power consumption, kW	2,8	3,9	4,6	8,2	7,4	7,7	10,5	13,3	16,2
			System COP, kW/kW	9,7	10,4	12,8	10,8	15,1	19,2	17,4	16,7	16,3

Cooling mode*

T, °C	35	27	Total cooling capacity, kW	18	26	50	54	73	93	115	127	154
RH, %	40	50	Supply temperature, °C	20	20	20	20	20	20	20	20	20
			Nominal compressor power consumption, kW	2,7	3,9	7,2	8,8	11,4	12,1	16,2	18,2	23,3
			System EER, kW/kW	5,3	5,5	6,3	5,6	6,0	7,2	6,8	6,7	6,4

* L rotary heat exchanger + heat pump

Size	B	H	L ^{1.1}	L ^{1.2}	L ^{1.3}	b	h	A
RHP 10	1000	1000	618	900	250	700	300	125
RHP 20	1150	1150	751	900	250	900	400	125
RHP 30	1300	1300	751	900	250	1000	500	125
RHP 40	1500	1520	751	900	250	1200	600	125
RHP 50	1700	1715	885	900	250	1400	700	125
RHP 60	1900	1920	885	900	250	1600	800	125
RHP 70	2100	2100	885	900	250	1800	900	125
RHP 80	2300	2420	1250	1500	-	2000	1000	125
RHP 90	2610	2650	1400	1500	-	2200	1100	125

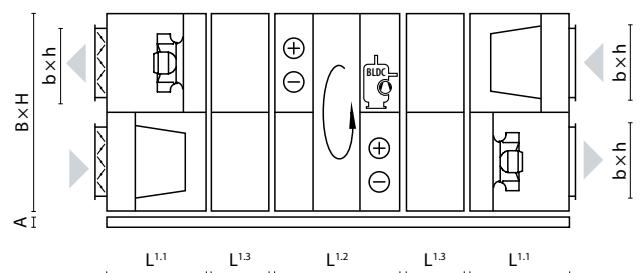

RHP Pro2

for larger area premises and higher heating / cooling capacity from 530 m³/h to 33 500 m³/h

Air flow

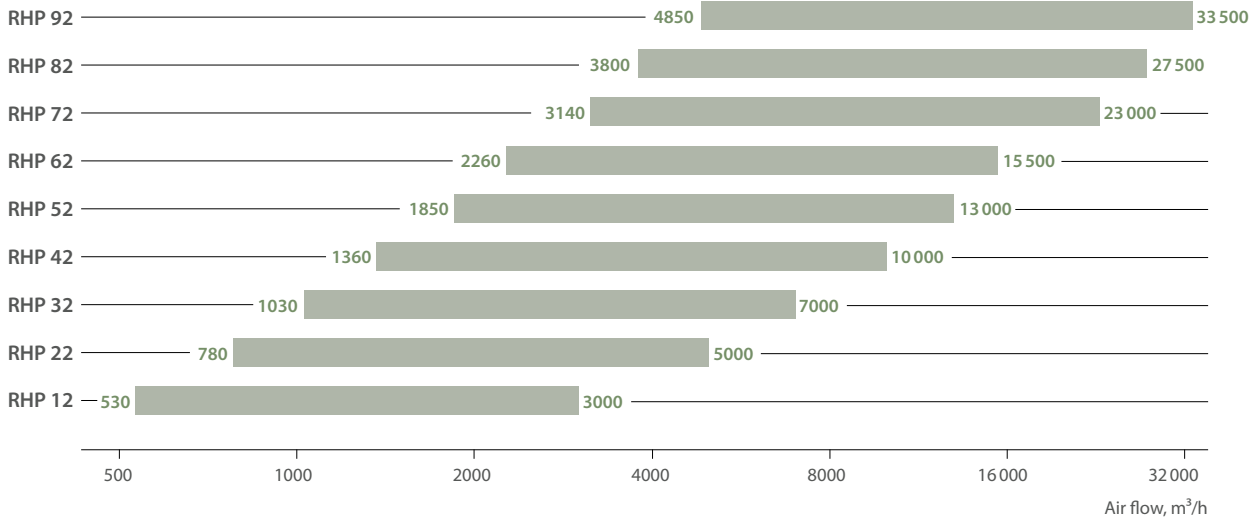

Outdoor	Indoor	Size	RHP 12	RHP 22	RHP 32	RHP 42	RHP 52	RHP 62	RHP 72	RHP 82	RHP 92
Conditions according to EN 14511		Max air flow, m ³ /h	3000	5000	7000	10000	13000	15500	23000	27500	33500
		Min air flow, m ³ /h	530	780	1030	1360	1850	2260	3140	3800	4850

Heating mode*

T, °C	-7	20	Total heating capacity, kW	36	59	80	118	149	178	258	301	375
RH, %	90	40	Supply temperature, °C	24	21,8	20,7	21,8	20,7	20,8	20	21,2	21,5
			Nominal compressor power consumption, kW	2,4	3,8	4,5	7,7	8,3	9,1	14,2	21,2	24,7
			System COP, kW/kW	11,7	12,9	15,2	14,0	16,4	18,0	17,6	14,2	14,9

Cooling mode*

T, °C	35	27	Total cooling capacity, kW	21	36	50	72	93	110	166	217	260
RH, %	40	50	Supply temperature, °C	20	20	20,1	20	20	20,2	20	19,8	19,3
			Nominal compressor power consumption, kW	2,4	4,2	7,2	8,8	11,8	13,3	22,6	25,7	30,5
			System EER, kW/kW	7,3	7,2	6,3	7,6	7,4	7,9	7,2	8,26	8,38

* L rotary heat exchanger + heat pump

Size	B	H	L ^{1.1}	L ^{1.2}	b	h	A
RHP 12	1054	1054	751	1450	700	300	125
RHP 22	1204	1204	751	1450	900	400	125
RHP 32	1354	1354	751	1450	1000	500	125
RHP 42	1554	1574	751	1450	1200	600	125
RHP 52	1754	1769	885	1450	1400	600	125
RHP 62	1954	1974	885	1450	1600	700	125
RHP 72	2154	2154	885	1450	1800	800	125
RHP 82	2360	2440	1250	1500	2000	1000	125
RHP 92	2660	2660	1400	1500	2300	1100	125

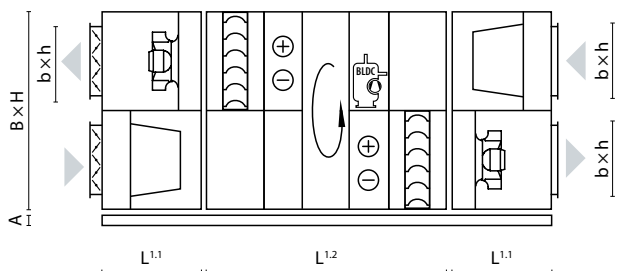

KOMBI

HYBRID heating
and ventilation unit

komfovent

All HVAC
systems
in one



The features of a KOMBI unit:

- Ready to use hybrid ventilation and heating unit;
- Simple planning / installation / maintenance;
- No outdoor unit needed – minimal impact on the exterior of the building;
- Easy HVAC system control with a single remote panel;
- Space saving solution;
- Large capacity domestic hot water tank;
- Option to use together with solar thermal collectors;
- Effective heating even up to -25 °C;
- Heating up to -30 °C with additional integrated electric heater;
- Maximum energy saving ensured by integrated intelligent control algorithms;
- Noise level control;
- 5-year warranty.



KLASIK

Unique Custom-made
Solutions



The series of unique ventilation units:
non-standard dimensions, hygienic applications,
a wide selection of internal components and
many other complex solutions

KLASIK range review



The widest range of options

KLASIK selection software offers the widest range of options – the dimensions of the equipment, the design solutions, the technical parameters of the heat exchangers, fans and other elements are presented there.

Energy saving components

It is possible to choose the most efficient components – non-freezing condensing or sorption-enthalpy rotary heat exchanger, counterflow plate heat exchanger, Super Premium IE4 class EC fans or Ultra Premium IE5 class PM fan.

Conformity with international standards

All KLASIK units are designed and made according EN (EN 13053, EN 13779, EN 1886), VDI (VDI 6022, VDI 3803/1), RLT (RLT 01) standards.

Modular or mono-block construction

KLASIK units consist of modules, as a result the transportation and installation of the unit is facilitated. Non-standard dimensions units and monoblocks are produced on request.

Quality certificates

KLASIK selection software and units are tested in the largest independent laboratories: Eurovent, TÜV, RLT.

C5 Control system

KLASIK air handling units can be ordered with an integrated and factory preset and tested C5 control system or order only automation box, which will be installed in the object. Automatic system C5 is designed for all thermodynamic processes (heating, cooling, ventilation, humidification, etc.) and has many safety and energy saving functions (CAV, VAV, DCV, timers, control according to temperature, humidity, CO₂ or air quality sensors).

Selection software

The KLASIK air handling unit software is designed to select the most sophisticated units with specific requirements. The widest selection of components: heat exchangers – rotary, plate cross and counter-flow, run around; heaters – electric, water, DX and gas, coolers – water, DX and adiabatic. The dimensions of the unit and other technical characteristics can be precisely adjusted according to the project requirements.

Sizes and capacities of KLASIK units

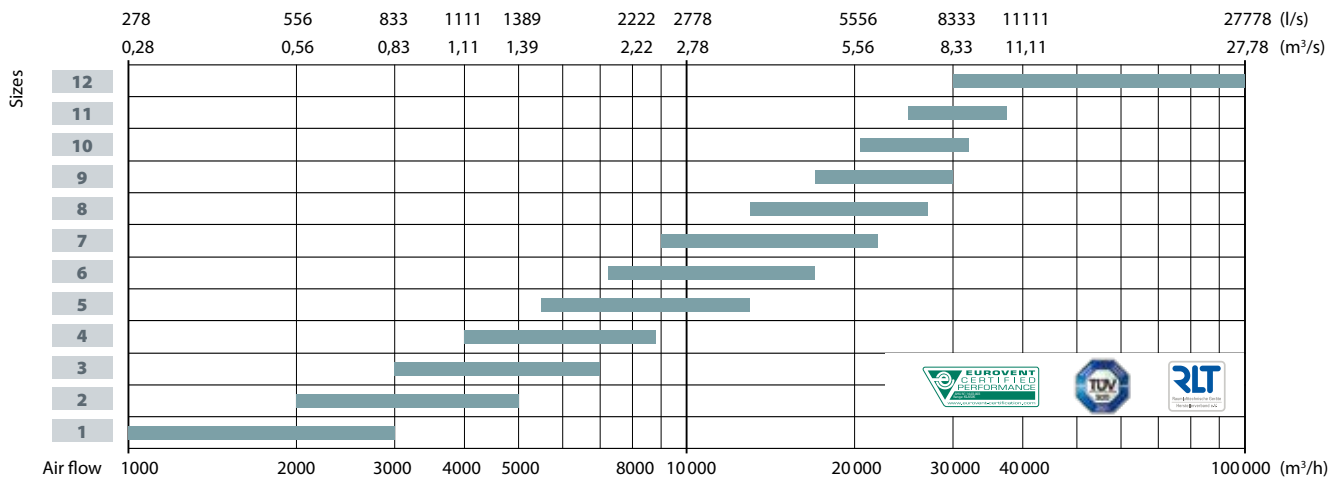

Unit types

KLASIK R

Air handling units with a rotary heat exchanger. Temperature efficiency and energy saving up to 86%. On request, a low profile unit with two parallel rotors can be manufactured.



KLASIK CF

Air handling units with a counterflow plate heat exchanger. Temperature efficiency and energy saving up to 92% in wet conditions and up to 88% in dry conditions. Upon request, it is possible to manufacture a low profile unit with fan / filters sections located side by side.



KLASIK S

Supply or exhaust air handling unit without heat recovery. On request, explosion-, corrosion- or high-temperature-resistant units can be ordered.



KLASIK RA

Air handling units with run-around coil heat exchanger.

Purpose

Ventilation units with separate air flow heat exchangers are used in cases where there must be 100% of supply and extract air flow separation:

- the extracted air is technologically contaminated with an aggressive, pungent odour or poisonous substances;
- the risk of biological contamination (medical institutions);
- high temperature of extract air.

Advantages

- The supply and extract air sections can be separated from each other.
- Compact size.
- The heat exchanger can be integrated into existing supply – extract ventilation system.

Specialized pipework package units LCHX for run around coil heat exchangers

- Depending on the operating conditions, the unit is filled with the corresponding concentration of ethylene glycol solution.
- Unit control signal 0 ... 10 V.

Maximum performance of the LCHX units

DN (mm)	20	25	32	40	50	65
Liquid flow (m ³ /h)	1,8	3,6	6,8	11	18	25



KLASIK units for hygienic application

Purpose

Hygienic ventilation units are designed for premises where sterile conditions are mandatory – such as hospitals, clinics, medical or pharmaceutical industry, clean rooms and etc.

RLT01 general requirements for hygienic application units

General requirements	Mechanical performance	Performance data	Hygiene requirements
EN 13053 EN 16798-3 VDI 3803-1 RLT 01	EN 13053 DIN 1751 EN 13501-1 RLT 01	EN 13053 EN 16798-3 VDI 3803-5 RLT 01	EN 13053 VDI 6022 DIN 1946/4 RLT 01

Casing

- Double-sealed panels filled with insulating material.
- Insulation class A1 or A2-s1 d0.
- All materials used are durable, with no accumulated humidity that might provide a supportive medium for microorganisms reproduction.
- Interior surfaces are smooth, without adsorption properties. No porous materials are used.
- Mechanical resistance not less than D2 class.
- Tightness is not worse than class L3 (leakage allowed not more than 2 % of the nominal air flow).
- The passage through the F7 air filters shall not exceed 2 % of the nominal air flow.
- Thermal conductivity is not higher than T4.
- Cold bridges are no worse than TB3.

Heat exchangers

- The system for supplying and discharging air should be recuperated, except where there is not enough room for it or the payback time is too long.
- Depending on the quality of the exhaust air quality, such types of heat exchangers are recommended: ETA2 – rotary or plate with overpressure; ETA3 – rotary or plate with overpressure; ETA4 – Separate Flow (Run Around coil) or Heat Pipe.
- A stainless steel or aluminium condensate tray is designed. Rotary heat exchanger condensate tray is necessary in exceptional cases.
- A rotor is recommended to be fitted with a purge section.
- To reduce the need for frost it is recommended to use adiabatic cooling by humidifying exhaust air.

Air filters

- Only filters that are tested in accordance with EN 779 or EN 1822 can be used.
- Each filter must be marked accordingly. Recommended is class ISO ePM2,5 ≥ 50 % in the extract air before the

heat recovery unit. In case of single-stage supply air filtering min. ISO ePM1 ≥ 50 %.

- The surface of the bag-type air filter must have at least 10 m² for 1 m² openings the area.
- Max. permitted maximum final pressure loss:
Filter class ISO ePM1 ≥ 70 % 300 Pa.
Filter class ISO ePM1 ≥ 50 % 200 Pa.
Filter class ISO ePM2,5 ≥ 50 % 200 Pa.
Filter class ISO ePM10 ≥ 50 % 200 Pa.

Dampers

- Air leakage class 2 for dampers that are closed while the system is in operation, e.g. mixing dampers or bypass dampers.
- Air velocity for dampers max. 8 m/s (except recirculation air and bypass dampers).
- The position of the damper must be visible from the outside of the damper.

Fans

- Fans with backward curved blades are preferred. Energy saving motors are recommended.
- Fan impeller generally protected against corrosion.
- It is recommended to use fans without belt drive (especially open impeller). Base frame of fan and motor in hot-dip galvanized steel sheeting.

Cooling coils

- Installation rails for cooling coils in stainless steel or aluminium.
- Condensate tray in stainless steel (AISI 304) or aluminium.
- Minimum fin spacing: 2 mm for cooling coil without dehumidification; 2,5 mm for cooling coil with dehumidification.

Humidifier section

- Humidifiers must not be placed directly upstream of filters or attenuator (exception: steam humidifiers).
- All components are demountable. All parts in contact with water accessible for inspection and cleaning and consisting of corrosion-resistant and disinfectant resistant material.
- Sealing compounds not be of material that can be metabolised.

Sound attenuator section

- Pressure drop max. 80 Pa.
- Surface quality material permanently abrasion-resistant and made of material that is durable when exposed to cleaning processes (e.g. fiberglass).
- Splitters demountable for cleaning without having to remove other parts.

KLASIK design



CASING

"Standart2"

Air handling units of the KLASIK series have a reliable and stable design. Casing frameworks are made of aluminium profiles and solid cast aluminium corner pieces. Covering panels are made of double-skin galvanized (corrosion resistance class C3), or stainless sheet steel (class C5) and is filled with fireproof thermal and sound insulation – 50 mm thickness mineral wool. On request, casing can be painted (class C4).

KLASIK gaskets and sealing are used to ensure perfect casing tightness and sound insulation.

All doors are hinged and equipped with handles which can be locked. Variable accessories such as adjustable feet, inspection windows, sections lighting, etc. are available at the customers' request.

Casing classification in conformance with standard EN 1886 and approved by Eurovent: thermal transmittance class T3; thermal bridging factor TB4; casing strength class D2; casing air leakage class L1; filter bypass leakage class F9.

"Standart2 TB"

Casing frameworks are made of aluminium profiles with thermal break system and plastic corners. Covering panels are made from double-skin galvanized or stainless sheet. The panels are 60 mm thickness: 50 mm mineral wool are used for thermal and sound insulation and 10 mm of pol-yurethane foam.

Casing classification in conformance with standard EN 1886 and approved by Eurovent : thermal transmittance class T2; thermal bridging factor TB2; casing strength class D1; casing air leakage class L1; filter bypass leakage class F9.

FILTERS

KLASIK units pocket synthetic or fiberglass filters with a class of filtration from G4 up to F9 are used.

Filters have big filtration surface which results in longer terms of exploitation.

Filters are fastened by a clamping mechanism that secures tightness and simplifies the filter replacement procedure.





HEAT EXCHANGERS

Rotary heat exchanger

Temperature efficiency – up to 86 %. Depending on required temperature efficiency η (%), the height of a wave of a rotor can be L, ML or SL.

Rotors may be offered of four types:

- aluminium;
- aluminium with a sorption (zeolite) coating;
- aluminium with an epoxy paint covering on embossed rotor edges;
- aluminium with deep epoxy coating.

The drive of a rotor is supplied with the frequency converter, allowing support for an optimum heat exchanger operating mode, smoothly changing speed of rotation of a rotor. Rotary heat exchanger can be equipped with purge sector on customers' request. A reduced height units with two rotors are also available.

Counter flow plate heat exchanger

Made of seawater-resistant aluminum plates. Temperature efficiency is 92% for condensation and up to 88% for dry air. An automatic bypass is integrated in the heat exchanger. The heat recovery section has stainless steel (AISI 304) sloping trays and a condensate drain trap.

Run-around type heat exchanger

Temperature efficiency – up to 70%.

In such a system coupled coils are placed in the supply and exhaust air. Coils are connected with pipes through a specialized PPU LCHX unit and are filled with a water-glycol mixture, which circulates around and transfers heat from one air flow to another. Air handling units with such heat recovery are used in cases when air streams must be absolutely separated or when on design features or other requirements the unit must be installed on different floors. Heat exchangers are made of copper pipes with aluminium fins.



AIR DAMPERS

Closing air dampers installed in the air handling units are produced from aluminium blades with rubber sealing complying to standard tightness – Class 2. Higher Class 3 or Class 4 dampers are offered as an option.



FANS

Fans are statically and dynamically balanced according to standard ISO 1940, corresponding to class G2,5/6,3 (at the maximal rotations).

Thus, even at the maximum rotation of the fan, vibration is minimal and meets modern requirements for ventilating equipment.

Depending on air volume and required static pressure, several types of fans are used in equipment.

Plug fans with EC/PM motor

Highly efficient in all operating areas, EC/PM motors are available in all types of KLASIK units and correspond to the IE4/IE5 Super/Ultra premium efficiency level. High efficiency is determined by low energy consumption, high efficiency factor and the best values of the SFP factor. By using EC/PM fans in KLASIK units the following advantages are achieved:

- extremely high efficiency up to 94 %;
- valuable energy saving up to 20 % compared with AC IE3 class motors;
- integrated motor controller, no need for a frequency converter;
- very smooth and silent operation;
- long-life;
- compact construction.

PM type motors correspond to the *Ultra Premium* Efficiency Class IE5 and ensure high efficiency in a wide operation range with reliable performance, durability, relatively low cost and electrical stability. Their operation is extremely smooth and silent, ensuring the highest efficiency, energy saving and accuracy in operation.

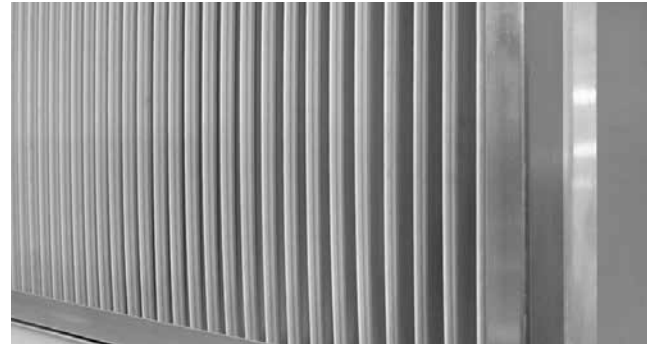

COOLERS AND HUMIDIFIERS

Water Air Coolers

Air coolers are made of copper tubes and aluminum fins (spacing 2,2; 2,6; 3,0; 3,4 mm) in galvanized steel casing insulated with a mineral wool. Air cooler section assembled with stainless steel sloping drain tray and water trap manifold pipes are covered with a condensation-proof material.

Maximum operating pressure – 21 bar.

Direct Evaporation Air Coolers

DX air coolers are made of copper tubes and aluminum fins (spacing 2,2; 2,6; 3,0; 3,4 mm) in galvanized steel casing insulated with a mineral wool. Air cooler section assembled with stainless steel sloping drain tray and water trap manifold pipes are covered with a condensation proof material.

Maximum operating pressure – 42 bar.

Power of direct evaporation air cooler can be divided into stages. It is necessary to indicate this when ordering.

Adiabatic humidifiers

Application areas: museums, light industry, paper industry, textile industry, wood industry, poultry farms, data centers.

Advantages: Hygienic Certificate VDI 6022, optimal performance and minimal operating costs, wide range of sizes and performance, easy maintenance, durability.

Technical characteristics:

- Air flow from 425 to 55 000 m³/h.
- Efficiency – up to 97 % RH.





AIR HEATERS

Hot water air heaters

Heaters are made of copper tubes and aluminum fins (spacing 2,2; 2,6; 3,0; 3,4 mm) in galvanized steel casing insulated with a mineral wool. As an option can be ordered with a threat joint to connect a freezing sensor. Capillary antifreeze sensor can also be ordered.

Maximum operating pressure – 21 bar.
Maximum water temperature +130 °C.
Heated air temperature up to +40 °C.

Electric air heaters

Three-phase (400 V/50Hz) stainless steel heating elements are used in production.

Two level protection ensures protection from overheating. Protection class IP54 in accordance with IEC 34-5.
Heated air temperature up to +40 °C.

SOUND ATTENUATOR SECTION

Integrated or separated silencers may be offered with air handling units. Integrated silencers have completely insulated casing. Sound attenuator splitters with resonating panels are mounted inside the section. Its elements can easily be removed through the door without using tools. The elements should be removed one by one, not as a whole block, thus providing easy dry or semi-moist cleaning for the purpose of sanitation of the ventilation system. The elements of the sound attenuator are filled with a special acoustic mineral wool.

The mineral wool is covered with a fiberglass mat preventing cotton particles from getting into an air channel when the air flow is running at high speed.

The fiberglass mat is maximally resistant to the occurrence of dust inside the air channel.

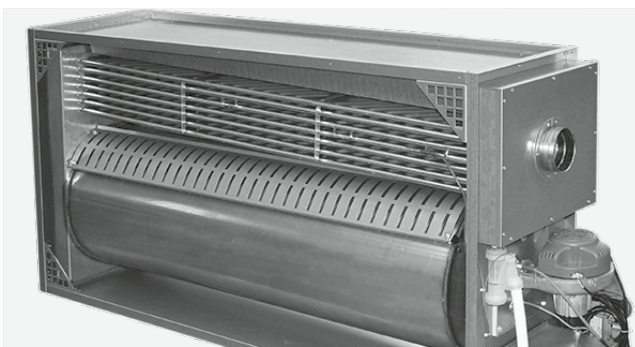

CONDENSING GAS HEATERS

Advantages of gas condensing heaters:

- there is no risk of freezing;
- no circulation pumps required;
- high temperature efficiency – up to 106 %;
- simpler installation;
- wide range from 22 to 125 kW.

ADDITIONAL ACCESSORIES

KLASIK air handling units can be outdoor type.

For such outdoor performance there is complete set enclosed consisting of: a protective roof, intake and exhaust air hoods, external grilles.

Also such additional elements are available: inspection window, additional sections: lighting, activated carbon air filter, UV lamp.

Accessories



Filters classification and standards

The introduction of the new standard ISO 16890 has established new classification based on efficiency classification system of air filters for general ventilation based upon particulate matter (PM). With the introduction of new standard, classification based on standard EN 779 becomes obsolete and familiar filter classes (M5 ... F9) will no longer apply.

New standard classifies filters into groups, based on particulate matter: *Coarse*, ePM10, ePM1.

In order for a filter to fall into each category its capturing efficiency should be at least 50% of the particulate in that size range. Filter efficiency is rounded off in steps of 5%, thus tested efficiency of 58% would resolve in 55%. Filters which are not able to capture 50% of PM10 dust are classified as Coarse filters.

Types of filters

Compact filters is characterized by longevity and a large filtering area. Filters have low-pressure losses – this in turn reduces power consumption. Filters are made of glass fabric with a cardboard frame, from environmentally friendly materials, which do not cause problems of utilization.

Changes to the KOMFOVENT products

For the purposes of smoother transition to the new classification all KOMFOVENT filters will carry marking of the filter class based on both standards.

Filter notation used in the name of air handling units will remain unchanged filters have been tested according to ISO 16890 and their efficiency is provided in the tables.

Bag filters

ISO 16890	EN 779:2012
Coarse 65 %	G4
ePM10 60 %	M5
ePM10 65 %	M6
ePM1 60 %	F7
ePM1 80 %	F9
ePM1 85 %	F9



Compact filters

ISO 16890	EN 779:2012
ePM10 50 %	M5
ePM1 60 %	F7



Panel pre-filter

ISO 16890	EN 779:2012
Coarse 65 %	G4



Silencers

To ensure the normal noise level in the system and premises, silencers are used. There are circular and rectangular silencers of standard dimensions.

An appropriate silencer can be selected using the selection program "Komfovent Silencer", which can be found on www.komfovent.com.

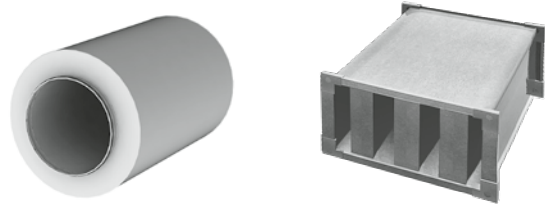

Motorized closing dampers

To protect air handling units from freezing or other external factors, motorized closing dampers must be used. They are mounted on supply and exhaust ducts. There is a possibility of damper control in the automatic control system.



Pipework package

Pipework Package Units (PPU) are used for water heater power regulation, i. e., for temperature control of supplied air by mixing hot water from a boiler with recycled water in a heat exchanger.

The fully assembled pipework package is available for each size of the air handling unit where a hot water heater is used.

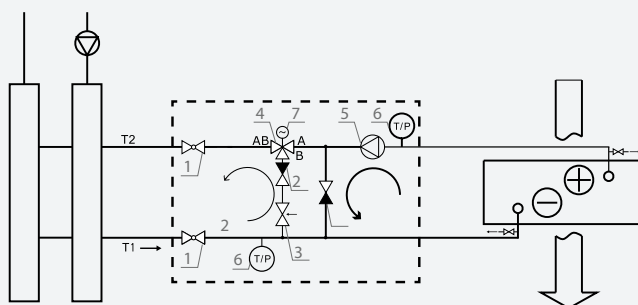

1. Stop valve
2. Return valve
3. Throttling valve
4. Control valve
5. Circulation pump
6. Thermomanometers
7. Actuator

Water and direct evaporation air coolers

The air cooler is mounted on the outside of the unit. Casing of the cooler section corresponds to the unit's casing: galvanized steel sheets with internal mineral wool insulation of 45 mm thickness. Cooler section is assembled with a drop separator and a drain tray. Cooler control function is provided in the automatic control system of the unit.

Internal fluid – R32, water 7/12 °C.

Air temperature in/out – 30/18 °C.

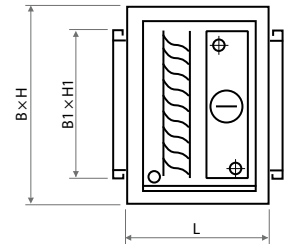

Supply air volume, m ³ /h	Cooler's type	Capacity, kW	Air pressure drop, Pa	Fluid pressure loss, kPa	BxHxL, mm	B1xH1, mm	Tubes connection ØD, "/mm	Weight, kg
200	DCW-0,2-1	1,3	10	13	450x400x390	300x200	1/2"	27
400	DCF-0,4-3	2,8	8	1	600x550x390	300x400	1/2" / 22	40
	DCW-0,4-3	2,6	21	25	505x550x390	300x400	1/2"	33
500	DCF-0,5-3	3,5	12	1	600x550x390	400x300	1/2" / 22	40
	DCW-0,5-3	3,3	18	46	600x550x390	400x300	1/2"	33
700	DCF-0,7-5	4,8	14	1	705x610x390	500x400	1/2" / 22	49
	DCW-0,7-5	4,5	17	15	705x610x390	500x400	1/2"	42
900	DCF-0,9-6	6,2	22	1	705x610x390	500x400	1/2" / 22	49
	DCW-0,9-6	5,5	23	5	705x610x390	500x400	3/4"	45
1200	DCF-1,2-8	8,3	37	1	705x610x390	500x400	1/2" / 22	49
	DCW-1,2-8	7,4	38	10	705x610x390	500x400	3/4"	45
1400	DCF-1,4-10	9,8	62	6,3	705x610x390	500x400	1/2" / 22	51
	DCW-1,4-9	8,7	50	13	705x610x390	500x400	3/4"	45
1600	DCF-1,6-11	11,2	66	8,8	755x610x420	500x400	1/2" / 22	56
	DCW-1,6-11	10	54	18	755x610x420	500x400	3/4"	46
2000	DCF-2,0-14	14	59	17	920x610x420	700x400	5/8" / 22	65
	DCW-2,0-13	12,8	50	32	920x610x420	700x400	3/4"	57
2500	DCF-2,5-17	17,1	56	8	1080x670x420	800x400	5/8" / 22	79
	DCW-2,5-17	15,5	63	13	1080x670x420	800x400	1"	65
3000	DCF-3,0-20-2	2x10,5	78	12	1080x670x420	800x400	2x5/8" / 2x22	79
	DCW-3,0-20	18,7	88	18	1080x670x420	800x400	1"	65
4000	DCF-4,0-27-2	2x14	68	13	1220x730x420	900x500	2x5/8" / 2x22	92
	DCW-4,0-27	25,2	92	32	1220x730x420	900x500	1"	82
4500	DCF-4,5-31-2	2x15,7	70	20	1220x730x420	900x600	2x5/8" / 2x22	98
	DCW-4,5-30	28,8	94	55	1220x790x420	900x600	1"	87
7000	DCF-7,0-48-3	3x16	90	7,2	1500x790x480	1200x600	3x5/8" / 3x22	131
	DCW-7,0-47	44,4	89	29	1500x790x420	1200x600	1 1/2"	105

Ducted heater DH and cooler DHCW

For use with DOMEKT and VERSO Standard units on supply air duct. Also must be used mixing unit PPU or 2-way valve with modulating actuator. DOMEKT units are prepared for 0...10 V actuator control.

Construction:

- Galvanised steel casing.
- Cu/Al heat exchanger.
- Anti-condensation casing covering and condensate drain (only for DHCW).



Maximal pressure – 10 bar.
Maximal fluid temperature – 130 °C.
Maximal air speed – 3 m/s.
Connection – ½".

Supply air volume, m ³ /h	Heater/cooler type	Air temp. in/out, °C	Internal fluid, water	Capacity, kW	Safety on capacity, %	Air pressure drop, Pa	Fluid pressure loss, kPa	BxHxL, mm	ØD, mm	Weight, kg
250	DH-125	10/22	60/40	1	32	13	1	335×295×152	125	6,2
400	DH-160	10/22	60/40	1,6	24	31	1	335×295×152	160	6,2
700	DH-200	10/22	60/40	2,8	20	56	1,6	360×320×152	200	7
900	DH-250	10/22	60/40	3,7	31	43	3,4	420×380×152	250	9,3
1200	DH-315	10/22	60/40	4,9	43	30	8,2	470×510×152	315	11,8
1600	DH-315 M	10/22	60/40	6,5	54	57	1,2	480×520×132	315	14,4
2000	DH-355	10/22	60/40	8,1	33	54	23	600×510×152	355	13,3
2000	SVK-700x400-2R	10/22	60/40	8,1	41	30	3,7	817×500×100	700×400	12
3000	SVK-700x400-2R	10/22	60/40	12,2	26	63	8	817×500×100	700×400	12
<hr/>										
250	DHCW-125	26/18	7/12	0,8	79	21	2,6	350×330×164	125	11,3
400	DHCW-160	26/18	7/12	1,3	47	49	6,8	350×330×164	160	11,1
700	DHCW-200	26/18	7/12	2,3	32	89	25	380×360×164	200	12,4
900	DHCW-250	26/18	7/12	3,0	8,2	56	22	440×420×164	250	15,4
1200	DHCW-315	26/18	7/12	3,8	49	48	5,7	567×510×164	315	21,6
1200	DHCW-315M	32/18	7/12	9,7	31	55	28	565×510×205	315	39,7
1600	DHCW-355	26/18	7/12	5,2	29	33	11	620×600×164	355	25,4

Electric ducted air heater (preheater)



The electric round duct heaters are intended to be used for heating of clean air in the ventilation systems. Also, heaters can be used for heating or preheating function with air handling units.

The heaters can be supplied with or without installed electronic controller, with pressure and flow monitoring system. The heater case is made of aluzinc coated metal sheet, with sealing rubber for a tight connection with ventilation ducts system. Stainless steel heating elements are used in the heaters. All heaters are equipped with 2 overheat thermostats. Automatic reset thermostat 60 °C is for controlling output air temperature, manual reset thermostat 100 °C is for cut-off function in case of overheating. To carry out a manual reset, a thermostat push button is installed on a heater's cover. Minimum air speed for heaters must be not less than 1,5 m/s. Standard operating range is from -30 °C up to 0 °C.

Type with integrated controller and flow monitoring	Heating capacity, kW	Voltage, V
EHC-125-1,0-1f SI/FC	1,0	1 ~ 230
EHC-160-1,0-1f SI/FC	1,0	1 ~ 230
EHC-160-1,5-1f SI/FC	1,5	1 ~ 230
EHC-160-2,0-1f SI/FC	2,0	1 ~ 230
EHC-200-1,0-1f SI/FC	1,0	1 ~ 230
EHC-200-1,5-1f SI/FC	1,5	1 ~ 230
EHC-200-2,0-1f SI/FC	2,0	1 ~ 230
EHC-250-2,0-1f SI/FC	2,0	1 ~ 230
EHC-250-3,0-1f SI/FC	3,0	1 ~ 230
EHC-315-2,0-1f SI/FC	2,0	1 ~ 230
EHC-315-3,0-1f SI/FC	3,0	1 ~ 230
EHC-315-6,0-3f-SI/FC	6,0	3 ~ 400
EHC-315-9,0-3f-SI/FC	9,0	3 ~ 400
EHC-400-9,0-3f-SI/FC	6,0	3 ~ 400

DX heat pumps/outdoor units



Advantages:

- R-32 eco-friendly refrigerant.
- Simple connectivity and control.
- DC Inverter – high performance rotary compressors.
- Smart defrost technology.
- High performance sigma type heat exchanger.
- Compact design – effective use of space.

Protective functions:

- Overvoltage protection.
- Compressor overload protection.
- Compressor thermal protection.
- Pressure protection.
- Fan motor thermal protection.

DX heat pump technical data

MODEL	MOU-12HFN8a	MOU-18HFN8a	MOU-24HFN8a	MOU-36HFN8a	MOU-48HFN8a	MOU-55HFN8a	MOU-280-HFN6	MOU-335-HFN6
Cooling capacity, kW	"3,5 (1,1~4,2)"	"5,3 (3,4~5,83)"	"7,03 (3,28~8,16)"	"10,55 (2,73~11,78)"	"14,07 (3,52~15,53)"	"15,24 (4,1~17,29)"	"28 (14,14~36,08)"	"33,5 (16,92~43,17)"
EER	2,89	3,42	2,54	2,79	2,57	2,58	2,33	2,19
SEER	6,1	7	6,2	6,1	6,1	6,1	6,35	6,42
Energy Efficiency Class	A++	A++	A++	A++	A++	A++	A+	A++
Heating capacity, kW	"3,8 (1,1~4,2)"	"5,6 (3,1~5,85)"	"7,62 (2,81~8,49)"	"11,72 (2,78~12,84)"	"16,12 (4,10~18,17)"	"18,17 (4,4~20,52)"	"31,5 (15,80~40,89)"	"37,5 (18,81~48,68)"
COP	3,45	3,57	3,01	3,27	2,82	2,79	3,71	3,3
SCOP	4,0	4,0	4,0	4,0	4,0	4,0	4,56	4,13
Energy Efficiency Class	A+	A+	A+	A+	A+	A+	A+	A+
Max input power, kW	2,15	2,5	3,7	5	6,9	7,5	12,02	15,3
Max pipe length, m	25	30	50	75	75	75	120	120
Max difference in level, m	10	20	25	30	30	30	40	40
Sound pressure, dB(A)	56	57	60	63	64	64	60	61
Dimension (W x D x H), mm	720x270x495	874x330x554	890x342x673	946x410x810	952x415x1333	952x415x1333	1120x528x1558	1120x528x1558
Net / Gross weight, kg	23,2/25,0	33,5/36,1	43,9/46,9	80,5/85	103,7/118,3	107,0/121,2	144 / 160	157/ 173
Refrigerant/charged volume, kg	R32/0,55	R32/1,1	R32/1,5	R32/1,5	R32/2,9	R32/3,0	R410A/6,5	R410A/8,0
Power supply, V	1 x 230	1 x 230	1 x 230	3 x 400	3 x 400	3 x 400	3 x 400	3 x 400
Pipe diameter, "	1/4" / 3/8"	1/4" / 1/2"	3/8" / 5/8"	3/8" / 5/8"	3/8" / 5/8"	3/8" / 5/8"	3/8" / 7/8"	1/2" / 1"
Operating temperature heating/cooling, °C	-20...+24/ -15...+50	-20...+24/ -15...+50	-20...+24/ -15...+50	-20...+24/ -15...+50	-20...+24/ -15...+50	-20...+24/ -15...+50	-20...+24/ -5...+48	-20...+24/ -5...+48
AHU kit model	KA8140	KA8140	KA8140	KA8140	KA8140	KA8140	AHUKZ-02D	AHUKZ-02D

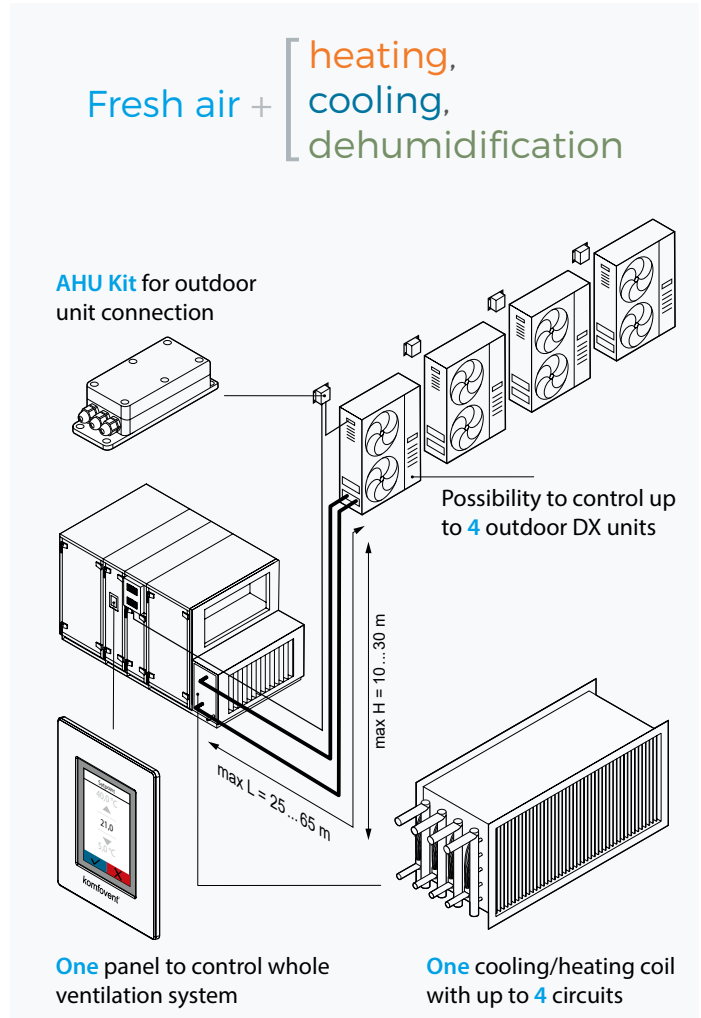

Accessories for unit outdoor installation

Air handling units can be installed outdoor due to thick casing insulation and easy mounting. Protective optional accessories should be used if the unit is for outdoor installation: roof, grills, supply and exhaust hoods.

SUPPLY AND EXHAUST HOODS



Unit size	Type of hood for supply air	Type of hood for exhaust air
R 1000 H C5 / CF 1000 H C5		
R 1300 H C5 / CF 1300 H C5		
R 1500 H C5		
RHP 800 UH C5	GAUBTAS_000_02_000	GAUBTAS_000_01_000
RHP 1300 UH C5		
RHP 1600 UH C5		
R 1700 H C5 / CF 1700 H C5		
R 2000 H C5	G_755_448_00	G_755_448_10
R 2500 H C5	VERSO-10-34-00.000.2	VERSO-10-34-00.000
R 3000 H C5		
R 4000 H C5	G_540_1115_00	G_540_1115_10
CF 3500 H C5		
R 5000 H C5	VERSO-30-34-00.000.2	VERSO-30-34-00.000
R 7000 H C5	V-40-34-00.000.2	V-40-34-00.000
CF 2300 H C5	G_355_870_00	G_355_870_10

Other accessories

STANDARD BASE FRAME



Base frame – painted RAL7035, with legs. There is a possibility to screw the adjustable legs with a rubber sole. They are assembled and ordered separately.

Unit size	Frame type	Dimensions BxHxL, mm
R 400 H C6M	BF_00_000_465x650	465x138x650
R 500 V C6	BF_00_000_590x1070	590x138x1070
R 600 H C6M	BF01_00_000_520x1060	520x138x1060
R 700 H C6M	BF_00_000_590x930	590x138x930
R 700 V C6	BF_00_000_590x1070	590x138x1070
R 1000 H/V C5		
R 1300 H/V C5	BF_00_000_852x1355	852x138x1355
R 1600 H/V C5		
R 1700 H/V C5		
R 2000 H/V C5	BF_00_000_852x1485	852x138x1485
R 3000 H/V C5		
R 4000 H/V C5	BF_00_000_1100x2100	1100x138x2100
CF 1000 H/V C5		
CF 1300 H/V C5	BF_00_000_852x1810	852x138x1810
CF 1700 H/V C5		
CF 2300 H/V C5	BF_00_000_852x2000	852x138x2000
CF 3500 H/V C5	BF_00_000_1100x2500	1100x138x2500

OUTDOOR GRILL LD

For supply and exhaust air flows' separation. (black RAL9005 or white RAL9010)

Type:
LD-125, LD-160, LD-200, LD-250, LD-315

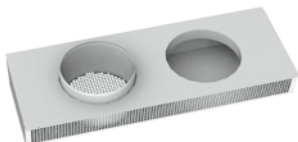

DECORATIVE PANEL

(only for unit Domekt R 200)



- White colour painted
- Stainless steel

AIR DISTRIBUTION BOX

OSD

(only for unit Domekt R 200 for horizontal connection of ducts)



- Type:
- OSD-200 VE (100 mm)
 - OSD2-200 VE (125 mm)

KITCHEN HOOD

(only for unit Domekt R 200)





- White colour painted
- Stainless steel



- White colour painted
- The height is only 2,6 cm

Air quality control (AQC)

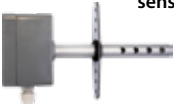
Upon connecting additional external air quality or humidity sensors, the ventilation intensity is chosen automatically. The air handling unit will slow down or can even be stopped when the air quality is at the user-set level and speeds up automatically if air quality is getting worse. In this way, optimum room comfort is ensured with the minimum energy cost. This function is available on all air handling units by default, just by connecting one or more of the sensors listed below.

Type	Parameters
 <p>Wall mounted CO₂, % RH and temperature sensor-controller "SCR"</p>	Supply voltage: 24 Vac / 24 Vdc, < 2 VA CO ₂ : 0...2000 ppm +/-6% % RH: +/- 3% Temperature: 0...50 °C, +/- 1 °C Output signal: 2x0...10 V selectable Protection class: IP30 Dimensions: 80x80x26 mm
 <p>Duct mounted CO₂, humidity and temperature sensor "SCD"</p>	Supply voltage: 24 Vac / 24 Vdc ±20 % CO ₂ : 0...2000 ppm Relative humidity: 0 % ... 100 % Temperature: 0 °C ... 50 °C 2 selectable output signals: 0...10 V RS-485 Modbus interface Relay output for on/off control Adjustable setpoint for VAV control Protection class: IP65 Dimensions: 82x80x54 (208) mm
 <p>Wall mounted air quality, % RH and temperature sensor-controller "SQR"</p>	Supply voltage: 24 Vac / 24 Vdc, < 2 VA VOC: 0-100 % Temperature: 0...50 °C, +/- 0,5 °C Output signal: 2 x 0...10 V selectable Protection class: IP30 Dimensions: 80x80x26 mm
 <p>Duct mounted air quality, humidity and temperature sensor "SQD"</p>	Supply voltage: 24 Vac / 24 Vdc ±20 % VOC: 0 ... 100 % Relative humidity: 0 % ... 100 % Temperature: 0 °C ... 50 °C 2 selectable output signals: 0...10 V RS-485 Modbus interface Relay output for on/off control Adjustable setpoint for VAV control Protection class: IP65 Dimensions: 82x80x54 (208) mm

Override function (OVR) – remote air flow corrections

An external device (timer, motion sensor, differential pressure switch, thermostat, etc.) can start override function and temporarily take over control of the unit. The signal received from the external device switches the unit to the user set air flow and temperature, ignoring the current operating mode and weekly schedule. This function has the highest priority and may operate in every mode, even when the unit is switched off.

Type	Parameters
 <p>Differential pressure switch DTV500</p>	Pressure range 50–500 Pa One change-over contact (NO+NC) 250V AC, 1A Protection class IP54

Wireless router



Wireless router provides a simple way to connect the ventilation unit to the Internet or a local network via Wi-Fi. Suitable for situations when there is no possibility for cable connection between AHU and internet access point. The router comes with a power supply (adapter and micro USB) and a computer network (Ethernet) cable. Transmission speeds up to 300 Mbps.

Variable air volume control (C5/C6/C6M)



VAV – control mode allows maintaining constant air pressure in ducts while the fan speed is adjusting according to pressure changes in the ventilation system correspondingly to the requirements in different premises. Air pressure in ducts is measured by optional VAV pressure sensors installed in supply and exhaust air ducts.

Unit marking and ordering samples

DOMEKT-R-450-V-L1-F7/M5-C6-L/A

1 2 3 4 5 6 7 8

- 1 **Series:** DOMEKT
- 2 **Type of heat exchanger:** R – rotary; CF – counterflow; S – supply unit
- 3 **Unit size:** 150, 200, 250, 300, 400, 450, 500, 600, 650, 700, 800, 900, 1000
- 4 **Duct connection:** V – vertical; H – horizontal; F – ceiling
- 5 **Inspection side:** R1; R2; L1; L2
- 6 **Air filter class:** F7/M5 (ePM1 60%/ePM10 50%)
- 7 **Controller:** C6, C6M, C8
- 8 **Heat exchangers characteristic:** L/A; L/AZ; ER (diffusion-enthalpy counterflow plate heat exchanger)

VERSO-R-1300-UH-E-L1-F7/M5-C5-SL/A

1 2 3 4 5 6 7 8 9

- 1 **Series:** VERSO
- 2 **Type of heat exchanger:** R – rotary; CF – counterflow; S – supply unit
- 3 **Unit size:** 1000, 1300, 1500, 1700, 2000, 2100, 2300, 2500, 3000, 3500, 4000, 5000, 7000
- 4 **Duct connection:** UH – universal/horizontal; UV – universal/vertical; H – horizontal; V – vertical; F – ceiling
- 5 **Heater type:** E – electric; W – water; HCW – heater-cooler; HCDX – heater-cooler direct expansion
- 6 **Inspection side:** R1; R2; L1; L2
- 7 **Air filter class:** F7/M5 (ePM1 60%/ePM10 50%)
- 8 **Control system:** C5
- 9 **Rotary characteristic:** L/A; SL/A; L/AZ

VERSO-RHP-600-3.7/3-UH-L1-F7/M5-C5-L/AZ

1 2 3 4 5 6 7 8 9

- 1 **Series:** VERSO
- 2 **Type:** RHP
- 3 **Unit size:** 400, 600, 800, 1200, 1600
- 4 **Heating / cooling capacity:** 3.7/3
- 5 **Duct connection:** UH – universal/horizontal; UV – universal/vertical; V – vertical
- 6 **Inspection side:** L1; R1
- 7 **Air filter class:** F7/M5 (ePM1 60%/ePM10 50%)
- 8 **Control system:** C5
- 9 **Rotary characteristic:** L/AZ

Inspection side

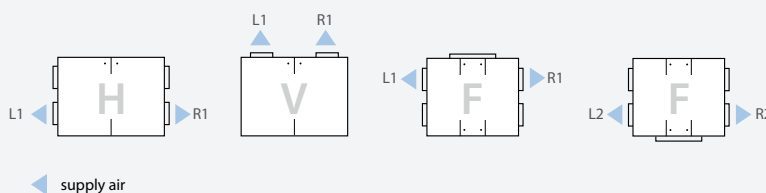

Inspection side is determined by the supply air direction, looking at the unit from the user's side.



Breathe with us
VENTILAIR
GROUP

Ventilair Group Belgium
Pieter Verhaeghestraat 8
8520 Kuurne
Belgium
Tel. +32 56 36 21 20
be@ventilairgroup.com

Ventilair Group Nederland B.V.
Kerver 16
5521 DB Eersel
Nederland
Tel. +31 497 36 00 31
info@ventilair.nl